



**PHILIPPINE NATIONAL OIL COMPANY**  
**PNOC BLDG. 6, ENERGY CENTER, RIZAL DRIVE**  
**BONIFACIO GLOBAL CITY, TAGUIG CITY**

## **PHILIPPINE BIDDING DOCUMENTS**

**Project Title : Supply and Delivery of Various Furniture**

**ITB No. : 2024-07-085**

**Sixth Edition**  
**July 2020**

# Table of Contents

<b>Glossary of Acronyms, Terms, and Abbreviations .....</b>	<b>3</b>
<b>Section I. Invitation to Bid.....</b>	<b>6</b>
<b>Section II. Instructions to Bidders.....</b>	<b>7</b>
1. Scope of Bid .....	11
2. Funding Information.....	11
3. Bidding Requirements .....	11
4. Corrupt, Fraudulent, Collusive, and Coercive Practices .....	12
5. Eligible Bidders.....	12
6. Origin of Goods .....	13
7. Subcontracts .....	13
8. Pre-Bid Conference .....	13
9. Clarification and Amendment of Bidding Documents .....	13
10. Documents comprising the Bid: Eligibility and Technical Components .....	13
11. Documents comprising the Bid: Financial Component .....	14
12. Bid Prices .....	14
13. Bid and Payment Currencies .....	14
14. Bid Security .....	15
15. Sealing and Marking of Bids .....	15
16. Deadline for Submission of Bids .....	15
17. Opening and Preliminary Examination of Bids .....	15
18. Domestic Preference .....	16
19. Detailed Evaluation and Comparison of Bids .....	16
20. Post-Qualification .....	16
21. Signing of the Contract .....	17
<b>Section III. Bid Data Sheet .....</b>	<b>18</b>
<b>Section IV. General Conditions of Contract .....</b>	<b>21</b>
1. Scope of Contract .....	22
2. Advance Payment and Terms of Payment .....	22
3. Performance Security .....	22
4. Inspection and Tests .....	22
5. Warranty .....	23
6. Liability of the Supplier .....	23
<b>Section V. Special Conditions of Contract .....</b>	<b>24</b>
<b>Section VI. Schedule of Requirements .....</b>	<b>29</b>
<b>Section VII. Technical Specifications .....</b>	<b>30</b>
<b>Section VIII. Checklist of Technical and Financial Documents .....</b>	<b>35</b>
<b>Section IX. Bid Forms.....</b>	<b>42</b>



# *Glossary of Acronyms, Terms, and Abbreviations*

**ABC** – Approved Budget for the Contract.

**BAC** – Bids and Awards Committee.

**Bid** – A signed offer or proposal to undertake a contract submitted by a bidder in response to and in consonance with the requirements of the bidding documents. Also referred to as *Proposal* and *Tender*. (2016 revised IRR, Section 5[c])

**Bidder** – Refers to a contractor, manufacturer, supplier, distributor and/or consultant who submits a bid in response to the requirements of the Bidding Documents. (2016 revised IRR, Section 5[d])

**Bidding Documents** – The documents issued by the Procuring Entity as the bases for bids, furnishing all information necessary for a prospective bidder to prepare a bid for the Goods, Infrastructure Projects, and/or Consulting Services required by the Procuring Entity. (2016 revised IRR, Section 5[e])

**BIR** – Bureau of Internal Revenue.

**BSP** – Bangko Sentral ng Pilipinas.

**Consulting Services** – Refer to services for Infrastructure Projects and other types of projects or activities of the GOP requiring adequate external technical and professional expertise that are beyond the capability and/or capacity of the GOP to undertake such as, but not limited to: (i) advisory and review services; (ii) pre-investment or feasibility studies; (iii) design; (iv) construction supervision; (v) management and related services; and (vi) other technical services or special studies. (2016 revised IRR, Section 5[i])

**CDA** - Cooperative Development Authority.

**Contract** – Refers to the agreement entered into between the Procuring Entity and the Supplier or Manufacturer or Distributor or Service Provider for procurement of Goods and Services; Contractor for Procurement of Infrastructure Projects; or Consultant or Consulting Firm for Procurement of Consulting Services; as the case may be, as recorded in the Contract Form signed by the parties, including all attachments and appendices thereto and all documents incorporated by reference therein.

**CIF** – Cost Insurance and Freight.

**CIP** – Carriage and Insurance Paid.

**CPI** – Consumer Price Index.

**DDP** – Refers to the quoted price of the Goods, which means “delivered duty paid.”



**DTI** – Department of Trade and Industry.

**EXW** – Ex works.

**FCA** – “Free Carrier” shipping point.

**FOB** – “Free on Board” shipping point.

**Foreign-funded Procurement or Foreign-Assisted Project**– Refers to procurement whose funding source is from a foreign government, foreign or international financing institution as specified in the Treaty or International or Executive Agreement. (2016 revised IRR, Section 5[b]).

**Framework Agreement** – Refers to a written agreement between a procuring entity and a supplier or service provider that identifies the terms and conditions, under which specific purchases, otherwise known as “Call-Offs,” are made for the duration of the agreement. It is in the nature of an option contract between the procuring entity and the bidder(s) granting the procuring entity the option to either place an order for any of the goods or services identified in the Framework Agreement List or not buy at all, within a minimum period of one (1) year to a maximum period of three (3) years. (GPPB Resolution No. 27-2019)

**GFI** – Government Financial Institution.

**GOCC** – Government-owned and/or –controlled corporation.

**Goods** – Refer to all items, supplies, materials and general support services, except Consulting Services and Infrastructure Projects, which may be needed in the transaction of public businesses or in the pursuit of any government undertaking, project or activity, whether in the nature of equipment, furniture, stationery, materials for construction, or personal property of any kind, including non-personal or contractual services such as the repair and maintenance of equipment and furniture, as well as trucking, hauling, janitorial, security, and related or analogous services, as well as procurement of materials and supplies provided by the Procuring Entity for such services. The term “related” or “analogous services” shall include, but is not limited to, lease or purchase of office space, media advertisements, health maintenance services, and other services essential to the operation of the Procuring Entity. (2016 revised IRR, Section 5[r])

**GOP** – Government of the Philippines.

**GPPB** – Government Procurement Policy Board.

**INCOTERMS** – International Commercial Terms.

**Infrastructure Projects** – Include the construction, improvement, rehabilitation, demolition, repair, restoration or maintenance of roads and bridges, railways, airports, seaports, communication facilities, civil works components of information technology projects, irrigation, flood control and drainage, water supply, sanitation, sewerage and solid waste management systems, shore protection, energy/power and electrification facilities, national



buildings, school buildings, hospital buildings, and other related construction projects of the government. Also referred to as *civil works or works*. (2016 revised IRR, Section 5[u])

**LGUs** – Local Government Units.

**NFCC** – Net Financial Contracting Capacity.

**NGA** – National Government Agency.

**PhilGEPS** - Philippine Government Electronic Procurement System.

**Procurement Project** – refers to a specific or identified procurement covering goods, infrastructure project or consulting services. A Procurement Project shall be described, detailed, and scheduled in the Project Procurement Management Plan prepared by the agency which shall be consolidated in the procuring entity's Annual Procurement Plan. (GPPB Circular No. 06-2019 dated 17 July 2019)

**PSA** – Philippine Statistics Authority.

**SEC** – Securities and Exchange Commission.

**SLCC** – Single Largest Completed Contract.

**Supplier** – refers to a citizen, or any corporate body or commercial company duly organized and registered under the laws where it is established, habitually established in business and engaged in the manufacture or sale of the merchandise or performance of the general services covered by his bid. (Item 3.8 of GPPB Resolution No. 13-2019, dated 23 May 2019). Supplier as used in these Bidding Documents may likewise refer to a distributor, manufacturer, contractor, or consultant.

**UN** – United Nations.

## ***Section I. Invitation to Bid***





**PHILIPPINE NATIONAL OIL COMPANY**

**PNOC Building 6, Energy Center**

**Rizal Drive, BGC, Taguig City**

**Tel No.: 8789-7662**

[www.pnoc.com.ph](http://www.pnoc.com.ph), [www.philgeps.gov.ph](http://www.philgeps.gov.ph)

**Invitation to Bid**

**Supply and Delivery of Various Furniture**

**Invitation to Bid No. 2024-07-085**

- Philippine National Oil Company (PNOC), through the *2024 Approved Corporate Operating Budget*, intends to apply the sum of,

<b>ITEM NO.</b>	<b>DESCRIPTION</b>	<b>QTY/ UOM</b>	<b>ABC</b>
1	<b>3-Seater Sofa (President’s Office)</b>	1 unit	60,900.00
2	<b>3- Seater Sofa (OP Lounge)</b>	1 unit	59,900.00
3	<b>Conference Table</b>	2 units	64,000.00
4	<b>6-Pax Work Station (table)</b>	2 units	287,400.00
5	<b>1-Seater Sofa (President’s Office &amp; Lounge)</b>	5 units	119,000.00
6	<b>1-Seater Chair</b>	4 units	68,800.00
7	<b>Office Chair</b>	18 units	129,600.00
8	<b>Lateral Filing Cabinet (4-Layers)</b>	4 units	70,800.00
9	<b>Vertical Filing Cabinet (4-Layers)</b>	3 units	33,000.00
10	<b>Mobile Pedestal</b>	12 units	44,400.00
11	<b>2-Seater Coffee Table Set</b>	3 units	127,800.00
12	<b>14- 16 Seater “U” Type Conference Table</b>	1 unit	193,800.00
13	<b>Podium Stand with storage shelf</b>	1 unit	60,000.00
14	<b>3- Seater Sofa</b>	1 unit	52,400.00
15	<b>Executive Chair</b>	40 units	268,000.00
16	<b>1- Seater Sofa (Lounge)</b>	2 units	47,600.00
<b>TOTATL ABC</b>			<b>1,687,400.00</b>

being the Approved Budget for the Contract (ABC) to payments under the contract for the *Supply and Delivery of Various Furniture* with identification number **2024-07-085**. Bids received in excess of the ABC shall be automatically rejected at bid opening.

- The PNOC now invites bids for the above Procurement Project. Delivery of Goods and Services and the completion of the project is required within **Sixty (60) Calendar Days**. Bidders should have completed, within five (5) years from the date of submission and receipt of bids, a contract similar to the project. The description of an eligible bidder is contained in the Bidding Documents, particularly, in Section II. (Instructions to Bidders).
- Bidding will be conducted through open competitive bidding procedures using a non-discretionary “*pass/fail*” criterion as specified in the 2016 Revised Implementing Rules



and Regulations (IRR) of Republic Act (RA) 9184, otherwise known as the “Government Procurement Reform Act”.

Bidding is restricted to Filipino citizens/sole proprietorships, partnerships, or organizations with at least sixty percent (60%) interest or outstanding capital stock belonging to citizens of the Philippines, and to citizens or organizations of a country the laws or regulations of which grant similar rights or privileges to Filipino citizens, pursuant to RA 5183.

4. Interested bidders may obtain further information from the PNOC-Procurement Management Division and inspect the Bidding Documents at the address given below during *working hours from 8:00 AM to 5:00 PM*.
5. A complete set of Bidding Documents may be acquired by interested Bidders on **July 11, 2024** from the given address below and upon payment of a non-refundable fee amounting to **One Thousand Six Hundred Pesos (PhP1,600.00)**. The procuring entity shall allow the bidder to present its proof of payment for the fees in person, by facsimile, or through electronic means.
6. The PNOC will hold a Pre-Bid Conference on **July 18, 2024 (09:30 AM)** at PNOC Bldg. 6, Energy Center, Rizal Drive, BGC, Taguig City and/or through video conferencing via **Zoom**, which shall be open to prospective bidders.
7. Bids must be duly received by the BAC Secretariat through manual submission at the address indicated below on or before **July 30, 2024 (10:00 AM)**. Late bids shall not be accepted.
8. All Bids must be accompanied by a bid security in any of the acceptable forms and in the amount stated in **ITB Clause 14**.
9. Bid opening shall be on **July 30, 2024 (11:00 AM)** at given address below and/or via **Zoom**. Bids will be opened in the presence of the bidders’ representatives who choose to attend the activity.
10. The PNOC reserves the right to reject any and all bids, declare a failure of bidding, or not award the contract at any time prior to contract award in accordance with Sections 35.6 and 41 of the 2016 revised IRR of RA No. 9184, without thereby incurring any liability to the affected bidder or bidders.
11. For further information, please refer to:

**The Secretariat  
Bids and Awards Committee  
Philippine National Oil Company**  
PNOC Bldg. 6, Energy Center  
Rizal Drive, BGC, Taguig City  
Telephone No. (02) 8789-7757  
E-Mail: [cfc\\_melo@pnoc.com.ph](mailto:cfc_melo@pnoc.com.ph) / [procurement@pnoc.com.ph](mailto:procurement@pnoc.com.ph)  
Website: [www.pnoc.com.ph](http://www.pnoc.com.ph)



12. For downloading of Bidding Documents  
[www.philgeps.com.ph](http://www.philgeps.com.ph) and <http://www.pnoc.com.ph/bids.php>

  
**ATTY. JOSEPHINE CASSANDRA J. CUI**  
**BAC Chairperson**  

## ***Section II. Instructions to Bidders***



## 1. Scope of Bid

The Procuring Entity, PNOG, wishes to receive Bids for the *Supply and Delivery of Various Furniture* including tools, equipment and materials, with identification number 2024-07-085.

The Procurement Project, *Supply and Delivery of Various Furniture* for PNOG is composed of Sixteen (16) Items, the details of which are described in Section VII (Technical Specifications).

## 2. Funding Information

2.1. The GOP through the source of funding as indicated below for 2024 Approved Corporate Operating Budget in the amount of,

ITEM NO.	DESCRIPTION	QTY/ UOM	ABC
1	3-Seater Sofa (President's Office)	1 unit	60,900.00
2	3- Seater Sofa (OP Lounge)	1 unit	59,900.00
3	Conference Table	2 units	64,000.00
4	6-Pax Work Station (table)	2 units	287,400.00
5	1-Seater Sofa (President's Office & Lounge)	5 units	119,000.00
6	1-Seater Chair	4 units	68,800.00
7	Office Chair	18 units	129,600.00
8	Lateral Filing Cabinet (4-Layers)	4 units	70,800.00
9	Vertical Filing Cabinet (4-Layers)	3 units	33,000.00
10	Mobile Pedestal	12 units	44,400.00
11	2-Seater Coffee Table Set	3 units	127,800.00
12	14- 16 Seater "U" Type Conference Table	1 unit	193,800.00
13	Podium Stand with storage shelf	1 unit	60,000.00
14	3- Seater Sofa	1 unit	52,400.00
15	Executive Chair	40 units	268,000.00
16	1- Seater Sofa (Lounge)	2 units	47,600.00
<b>TOTAL ABC</b>			<b>1,687,400.00</b>

2.2. The source of funding is the Approved Corporate Operating Budget.

## 3. Bidding Requirements

The Bidding for the Project shall be governed by all the provisions of RA No. 9184 and its 2016 revised IRR, including its Generic Procurement Manuals and associated policies, rules and regulations as the primary source thereof, while the herein clauses shall serve as the secondary source thereof.

Any amendments made to the IRR and other GPPB issuances shall be applicable only to the ongoing posting, advertisement, or IB by the BAC through the issuance of a supplemental or bid bulletin.



The Bidder, by the act of submitting its Bid, shall be deemed to have verified and accepted the general requirements of this Project, including other factors that may affect the cost, duration and execution or implementation of the contract, project, or work and examine all instructions, forms, terms, and project requirements in the Bidding Documents.

#### **4. Corrupt, Fraudulent, Collusive, and Coercive Practices**

The Procuring Entity, as well as the Bidders and Suppliers, shall observe the highest standard of ethics during the procurement and execution of the contract. They or through an agent shall not engage in corrupt, fraudulent, collusive, coercive, and obstructive practices defined under Annex "I" of the 2016 revised IRR of RA No. 9184 or other integrity violations in competing for the Project.

#### **5. Eligible Bidders**

5.1. Only Bids of Bidders found to be legally, technically, and financially capable will be evaluated.

5.2. *[Select one, delete other/s]*

a. Foreign ownership exceeding those allowed under the rules may participate pursuant to:

i. When a Treaty or International or Executive Agreement as provided in Section 4 of the RA No. 9184 and its 2016 revised IRR allow foreign bidders to participate;

ii. Citizens, corporations, or associations of a country, included in the list issued by the GPPB, the laws or regulations of which grant reciprocal rights or privileges to citizens, corporations, or associations of the Philippines;

iii. When the Goods sought to be procured are not available from local suppliers; or

iv. When there is a need to prevent situations that defeat competition or restrain trade.

b. Foreign ownership limited to those allowed under the rules may participate in this Project.

5.3. Pursuant to Section 23.4.1.3 of the 2016 revised IRR of RA No.9184, the Bidder shall have an SLCC that is at least one (1) contract similar to the Project the value of which, adjusted to current prices using the PSA's CPI, must be at least equivalent to:

a. For the procurement of Non-expendable Supplies and Services: The Bidder must have completed a single contract that is similar to this Project, equivalent to at least fifty percent (50%) of the ABC.



- 5.4. The Bidders shall comply with the eligibility criteria under Section 23.4.1 of the 2016 IRR of RA No. 9184.

## **6. Origin of Goods**

There is no restriction on the origin of goods other than those prohibited by a decision of the UN Security Council taken under Chapter VII of the Charter of the UN, subject to Domestic Preference requirements under ITB Clause 18.

## **7. Subcontracts**

- 7.1. The Bidder may subcontract portions of the Project to the extent allowed by the Procuring Entity as stated herein, but in no case more than twenty percent (20%) of the Project.

The Procuring Entity has prescribed that subcontracting is not allowed.

## **8. Pre-Bid Conference**

The Procuring Entity will hold a pre-bid conference for this Project on the specified date and time and either at its physical address and/or through videoconferencing/webcasting as indicated in paragraph 6 of the IB.

## **9. Clarification and Amendment of Bidding Documents**

Prospective bidders may request for clarification on and/or interpretation of any part of the Bidding Documents. Such requests must be in writing and received by the Procuring Entity, either at its given address or through electronic mail indicated in the IB, at least ten (10) calendar days before the deadline set for the submission and receipt of Bids.

## **10. Documents comprising the Bid: Eligibility and Technical Components**

- 10.1. The first envelope shall contain the eligibility and technical documents of the Bid as specified in **Section VIII (Checklist of Technical and Financial Documents)**.
- 10.2. The Bidder's SLCC as indicated in ITB Clause 5.3 should have been completed within *five (5) years* prior to the deadline for the submission and receipt of bids.
- 10.3. If the eligibility requirements or statements, the bids, and all other documents for submission to the BAC are in foreign language other than English, it must be accompanied by a translation in English, which shall be authenticated by the appropriate Philippine foreign service establishment, post, or the equivalent office having jurisdiction over the foreign bidder's affairs in the Philippines. Similar to the required authentication above, for Contracting Parties to the Apostille Convention, only the translated documents shall be authenticated through an apostille pursuant to GPPB Resolution No. 13-2019 dated 23 May 2019. The English translation shall govern, for purposes of interpretation of the bid.



## 11. Documents comprising the Bid: Financial Component

- 11.1. The second bid envelope shall contain the financial documents for the Bid as specified in **Section VIII (Checklist of Technical and Financial Documents)**.
- 11.2. If the Bidder claims preference as a Domestic Bidder or Domestic Entity, a certification issued by DTI shall be provided by the Bidder in accordance with Section 43.1.3 of the 2016 revised IRR of RA No. 9184.
- 11.3. Any bid exceeding the ABC indicated in paragraph 1 of the **IB** shall not be accepted.
- 11.4. For Foreign-funded Procurement, a ceiling may be applied to bid prices provided the conditions are met under Section 31.2 of the 2016 revised IRR of RA No. 9184.

## 12. Bid Prices

- 12.1. Prices indicated on the Price Schedule shall be entered separately in the following manner:
  - a. For Goods offered from within the Procuring Entity's country:
    - i. The price of the Goods quoted EXW (ex-works, ex-factory, ex-warehouse, ex-showroom, or off-the-shelf, as applicable);
    - ii. The cost of all customs duties and sales and other taxes already paid or payable;
    - iii. The cost of transportation, insurance, and other costs incidental to delivery of the Goods to their final destination; and
    - iv. The price of other (incidental) services, if any, listed in e.
  - b. For Goods offered from abroad:
    - i. Unless otherwise stated in the **BDS**, the price of the Goods shall be quoted delivered duty paid (DDP) with the place of destination in the Philippines as specified in the **BDS**. In quoting the price, the Bidder shall be free to use transportation through carriers registered in any eligible country. Similarly, the Bidder may obtain insurance services from any eligible source country.
    - ii. The price of other (incidental) services, if any, as listed in **Section VII (Technical Specifications)**.

## 13. Bid and Payment Currencies



- 13.1. For Goods that the Bidder will supply from outside the Philippines, the bid prices may be quoted in the local currency or tradeable currency accepted by the BSP at the discretion of the Bidder. However, for purposes of bid evaluation, Bids denominated in foreign currencies, shall be converted to Philippine currency based on the exchange rate as published in the BSP reference rate bulletin on the day of the bid opening.
- 13.2. Payment of the contract price shall be made in Philippine Pesos.

#### **14. Bid Security**

- 14.1. The Bidder shall submit a Bid Securing Declaration<sup>1</sup> or any form of Bid Security in the amount indicated in the **BDS**, which shall be not less than the percentage of the ABC in accordance with the schedule in the **BDS**.
- 14.2. The Bid and bid security shall be valid until *[indicate date]*. Any Bid not accompanied by an acceptable bid security shall be rejected by the Procuring Entity as non-responsive.

#### **15. Sealing and Marking of Bids**

Each Bidder shall submit one copy of the first and second components of its Bid.

The Procuring Entity may request additional hard copies and/or electronic copies of the Bid. However, failure of the Bidders to comply with the said request shall not be a ground for disqualification.

If the Procuring Entity allows the submission of bids through online submission or any other electronic means, the Bidder shall submit an electronic copy of its Bid, which must be digitally signed. An electronic copy that cannot be opened or is corrupted shall be considered non-responsive and, thus, automatically disqualified.

#### **16. Deadline for Submission of Bids**

- 16.1. The Bidders shall submit on the specified date and time and either at its physical address or through online submission as indicated in paragraph 7 of the **IB**.

#### **17. Opening and Preliminary Examination of Bids**

- 17.1. The BAC shall open the Bids in public at the time, on the date, and at the place specified in paragraph 9 of the **IB**. The Bidders' representatives who are present shall sign a register evidencing their attendance. In case videoconferencing, webcasting or other similar technologies will be used, attendance of participants shall likewise be recorded by the BAC Secretariat.

---

<sup>1</sup> In the case of Framework Agreement, the undertaking shall refer to entering into contract with the Procuring Entity and furnishing of the performance security or the performance securing declaration within ten (10) calendar days from receipt of Notice to Execute Framework Agreement.



In case the Bids cannot be opened as scheduled due to justifiable reasons, the rescheduling requirements under Section 29 of the 2016 revised IRR of RA No. 9184 shall prevail.

- 17.2. The preliminary examination of bids shall be governed by Section 30 of the 2016 revised IRR of RA No. 9184.

## **18. Domestic Preference**

- 18.1. The Procuring Entity will grant a margin of preference for the purpose of comparison of Bids in accordance with Section 43.1.2 of the 2016 revised IRR of RA No. 9184.

## **19. Detailed Evaluation and Comparison of Bids**

- 19.1. The Procuring BAC shall immediately conduct a detailed evaluation of all Bids rated "*passed*," using non-discretionary pass/fail criteria. The BAC shall consider the conditions in the evaluation of Bids under Section 32.2 of the 2016 revised IRR of RA No. 9184.

- 19.2. If the Project allows partial bids, bidders may submit a proposal on any of the lots or items, and evaluation will be undertaken on a per lot or item basis, as the case maybe. In this case, the Bid Security as required by **ITB** Clause 15 shall be submitted for each lot or item separately.

- 19.3. The descriptions of the lots or items shall be indicated in **Section VII (Technical Specifications)**, although the ABCs of these lots or items are indicated in the **BDS** for purposes of the NFCC computation pursuant to Section 23.4.2.6 of the 2016 revised IRR of RA No. 9184. The NFCC must be sufficient for the total of the ABCs for all the lots or items participated in by the prospective Bidder.

- 19.4. The Project shall be awarded as follows:

One Project having several items, which shall be awarded as separate contracts per item.

- 19.5. Except for bidders submitting a committed Line of Credit from a Universal or Commercial Bank in lieu of its NFCC computation, all Bids must include the NFCC computation pursuant to Section 23.4.1.4 of the 2016 revised IRR of RA No. 9184, which must be sufficient for the total of the ABCs for all the lots or items participated in by the prospective Bidder. For bidders submitting the committed Line of Credit, it must be at least equal to ten percent (10%) of the ABCs for all the lots or items participated in by the prospective Bidder.

## **20. Post-Qualification**

- 20.2. Within a non-extendible period of five (5) calendar days from receipt by the Bidder of the notice from the BAC that it submitted the Lowest Calculated Bid, the Bidder shall submit its latest income and business tax returns filed and paid



through the BIR Electronic Filing and Payment System (eFPS) and other appropriate licenses and permits required by law and stated in the **BDS**.

## **21. Signing of the Contract**

- 21.1. The documents required in Section 37.2 of the 2016 revised IRR of RA No. 9184 shall form part of the Contract. Additional Contract documents are indicated in the **BDS**.

## ***Section III. Bid Data Sheet***



# Bid Data Sheet

ITB Clause																																																																											
5.3	For this purpose, contracts similar to the Project shall be:  Supply and Delivery of Various Furniture within the last <i>five (5) years</i> prior to the deadline for submission and opening of bids.																																																																										
7.1	<i>Sub-contracting is not allowed</i>																																																																										
12	No further instructions																																																																										
14.1	The bid security shall be in the form of a Bid Securing Declaration, or any of the following forms and amounts: <ul style="list-style-type: none"> <li>a. The amount of not less than <b>Thirty-Three Thousand Seven Hundred Forty-Eight Pesos (PhP 33,748.00)</b> or two percent (2%) of ABC, if bid security is in cash, cashier's/manager's check, bank draft/guarantee or irrevocable letter of credit; or</li> <li>b. The amount of not less than <b>Eighty-Four Thousand Three Hundred Seventy Pesos (PhP 84,370.00)</b> or five percent (5%) of ABC if bid security is in Surety Bond.</li> </ul>																																																																										
19.3	<b>Supply and Delivery of Various Furniture</b>  <b>ABC:</b> <table border="1" style="width: 100%; border-collapse: collapse; margin-top: 5px;"> <thead> <tr> <th style="width: 8%;">ITEM NO.</th> <th style="width: 55%;">DESCRIPTION</th> <th style="width: 15%;">QTY/ UOM</th> <th style="width: 22%;">ABC</th> </tr> </thead> <tbody> <tr><td style="text-align: center;">1</td><td><b>3-Seater Sofa (President's Office)</b></td><td style="text-align: center;">1 unit</td><td style="text-align: right;">60,900.00</td></tr> <tr><td style="text-align: center;">2</td><td><b>3- Seater Sofa (OP Lounge)</b></td><td style="text-align: center;">1 unit</td><td style="text-align: right;">59,900.00</td></tr> <tr><td style="text-align: center;">3</td><td><b>Conference Table</b></td><td style="text-align: center;">2 units</td><td style="text-align: right;">64,000.00</td></tr> <tr><td style="text-align: center;">4</td><td><b>6-Pax Work Station (table)</b></td><td style="text-align: center;">2 units</td><td style="text-align: right;">287,400.00</td></tr> <tr><td style="text-align: center;">5</td><td><b>1-Seater Sofa (President's Office &amp; Lounge)</b></td><td style="text-align: center;">5 units</td><td style="text-align: right;">119,000.00</td></tr> <tr><td style="text-align: center;">6</td><td><b>1-Seater Chair</b></td><td style="text-align: center;">4 units</td><td style="text-align: right;">68,800.00</td></tr> <tr><td style="text-align: center;">7</td><td><b>Office Chair</b></td><td style="text-align: center;">18 units</td><td style="text-align: right;">129,600.00</td></tr> <tr><td style="text-align: center;">8</td><td><b>Lateral Filing Cabinet (4-Layers)</b></td><td style="text-align: center;">4 units</td><td style="text-align: right;">70,800.00</td></tr> <tr><td style="text-align: center;">9</td><td><b>Vertical Filing Cabinet (4-Layers)</b></td><td style="text-align: center;">3 units</td><td style="text-align: right;">33,000.00</td></tr> <tr><td style="text-align: center;">10</td><td><b>Mobile Pedestal</b></td><td style="text-align: center;">12 units</td><td style="text-align: right;">44,400.00</td></tr> <tr><td style="text-align: center;">11</td><td><b>2-Seater Coffee Table Set</b></td><td style="text-align: center;">3 units</td><td style="text-align: right;">127,800.00</td></tr> <tr><td style="text-align: center;">12</td><td><b>14- 16 Seater "U" Type Conference Table</b></td><td style="text-align: center;">1 unit</td><td style="text-align: right;">193,800.00</td></tr> <tr><td style="text-align: center;">13</td><td><b>Podium Stand with storage shelf</b></td><td style="text-align: center;">1 unit</td><td style="text-align: right;">60,000.00</td></tr> <tr><td style="text-align: center;">14</td><td><b>3- Seater Sofa</b></td><td style="text-align: center;">1 unit</td><td style="text-align: right;">52,400.00</td></tr> <tr><td style="text-align: center;">15</td><td><b>Executive Chair</b></td><td style="text-align: center;">40 units</td><td style="text-align: right;">268,000.00</td></tr> <tr><td style="text-align: center;">16</td><td><b>1- Seater Sofa (Lounge)</b></td><td style="text-align: center;">2 units</td><td style="text-align: right;">47,600.00</td></tr> <tr> <td colspan="3" style="text-align: right;"><b>TOTAL ABC</b></td> <td style="text-align: right;"><b>1,687,400.00</b></td> </tr> </tbody> </table>			ITEM NO.	DESCRIPTION	QTY/ UOM	ABC	1	<b>3-Seater Sofa (President's Office)</b>	1 unit	60,900.00	2	<b>3- Seater Sofa (OP Lounge)</b>	1 unit	59,900.00	3	<b>Conference Table</b>	2 units	64,000.00	4	<b>6-Pax Work Station (table)</b>	2 units	287,400.00	5	<b>1-Seater Sofa (President's Office &amp; Lounge)</b>	5 units	119,000.00	6	<b>1-Seater Chair</b>	4 units	68,800.00	7	<b>Office Chair</b>	18 units	129,600.00	8	<b>Lateral Filing Cabinet (4-Layers)</b>	4 units	70,800.00	9	<b>Vertical Filing Cabinet (4-Layers)</b>	3 units	33,000.00	10	<b>Mobile Pedestal</b>	12 units	44,400.00	11	<b>2-Seater Coffee Table Set</b>	3 units	127,800.00	12	<b>14- 16 Seater "U" Type Conference Table</b>	1 unit	193,800.00	13	<b>Podium Stand with storage shelf</b>	1 unit	60,000.00	14	<b>3- Seater Sofa</b>	1 unit	52,400.00	15	<b>Executive Chair</b>	40 units	268,000.00	16	<b>1- Seater Sofa (Lounge)</b>	2 units	47,600.00	<b>TOTAL ABC</b>			<b>1,687,400.00</b>
ITEM NO.	DESCRIPTION	QTY/ UOM	ABC																																																																								
1	<b>3-Seater Sofa (President's Office)</b>	1 unit	60,900.00																																																																								
2	<b>3- Seater Sofa (OP Lounge)</b>	1 unit	59,900.00																																																																								
3	<b>Conference Table</b>	2 units	64,000.00																																																																								
4	<b>6-Pax Work Station (table)</b>	2 units	287,400.00																																																																								
5	<b>1-Seater Sofa (President's Office &amp; Lounge)</b>	5 units	119,000.00																																																																								
6	<b>1-Seater Chair</b>	4 units	68,800.00																																																																								
7	<b>Office Chair</b>	18 units	129,600.00																																																																								
8	<b>Lateral Filing Cabinet (4-Layers)</b>	4 units	70,800.00																																																																								
9	<b>Vertical Filing Cabinet (4-Layers)</b>	3 units	33,000.00																																																																								
10	<b>Mobile Pedestal</b>	12 units	44,400.00																																																																								
11	<b>2-Seater Coffee Table Set</b>	3 units	127,800.00																																																																								
12	<b>14- 16 Seater "U" Type Conference Table</b>	1 unit	193,800.00																																																																								
13	<b>Podium Stand with storage shelf</b>	1 unit	60,000.00																																																																								
14	<b>3- Seater Sofa</b>	1 unit	52,400.00																																																																								
15	<b>Executive Chair</b>	40 units	268,000.00																																																																								
16	<b>1- Seater Sofa (Lounge)</b>	2 units	47,600.00																																																																								
<b>TOTAL ABC</b>			<b>1,687,400.00</b>																																																																								

20.2	No additional requirement
21.2	No additional requirement



## ***Section IV. General Conditions of Contract***

## 1. **Scope of Contract**

This Contract shall include all such items, although not specifically mentioned, that can be reasonably inferred as being required for its completion as if such items were expressly mentioned herein. All the provisions of RA No. 9184 and its 2016 revised IRR, including the Generic Procurement Manual, and associated issuances, constitute the primary source for the terms and conditions of the Contract, and thus, applicable in contract implementation. Herein clauses shall serve as the secondary source for the terms and conditions of the Contract.

This is without prejudice to Sections 74.1 and 74.2 of the 2016 revised IRR of RA No. 9184 allowing the GPPB to amend the IRR, which shall be applied to all procurement activities, the advertisement, posting, or invitation of which were issued after the effectivity of the said amendment.

Additional requirements for the completion of this Contract shall be provided in the **Special Conditions of Contract (SCC)**.

## 2. **Advance Payment and Terms of Payment**

- 2.1. Advance payment of the contract amount is provided under Annex "D" of the revised 2016 IRR of RA No. 9184.
- 2.2. The Procuring Entity is allowed to determine the terms of payment on the partial or staggered delivery of the Goods procured, provided such partial payment shall correspond to the value of the goods delivered and accepted in accordance with prevailing accounting and auditing rules and regulations. The terms of payment are indicated in the **SCC**.

## 3. **Performance Security**

Within ten (10) calendar days from receipt of the Notice of Award by the Bidder from the Procuring Entity but in no case later than prior to the signing of the Contract by both parties, the successful Bidder shall furnish the performance security in any of the forms prescribed in Section 39 of the 2016 revised IRR of RA No. 9184.

## 4. **Inspection and Tests**

The Procuring Entity or its representative shall have the right to inspect and/or to test the Goods to confirm their conformity to the Project specifications at no extra cost to the Procuring Entity in accordance with the Generic Procurement Manual. In addition to tests in the **SCC, Section IV (Technical Specifications)** shall specify what inspections and/or tests the Procuring Entity requires, and where they are to be conducted. The Procuring Entity shall notify the Supplier in writing, in a timely manner, of the identity of any representatives retained for these purposes.

All reasonable facilities and assistance for the inspection and testing of Goods, including access to drawings and production data, shall be provided by the Supplier to the authorized inspectors at no charge to the Procuring Entity.



## **5. Warranty**

- 6.1. In order to assure that manufacturing defects shall be corrected by the Supplier, a warranty shall be required from the Supplier as provided under Section 62.1 of the 2016 revised IRR of RA No. 9184.
- 6.2. The Procuring Entity shall promptly notify the Supplier in writing of any claims arising under this warranty. Upon receipt of such notice, the Supplier shall, repair or replace the defective Goods or parts thereof without cost to the Procuring Entity, pursuant to the Generic Procurement Manual.

## **6. Liability of the Supplier**

The Supplier's liability under this Contract shall be as provided by the laws of the Republic of the Philippines.

If the Supplier is a joint venture, all partners to the joint venture shall be jointly and severally liable to the Procuring Entity.

## ***Section V. Special Conditions of Contract***



## Special Conditions of Contract

GCC Clause	
1	<p><b>Delivery and Documents –</b></p> <p>For purposes of the Contract, “EXW,” “FOB,” “FCA,” “CIF,” “CIP,” “DDP” and other trade terms used to describe the obligations of the parties shall have the meanings assigned to them by the current edition of INCOTERMS published by the International Chamber of Commerce, Paris. The Delivery terms of this Contract shall be as follows:</p> <p>The delivery terms applicable to the Contract are delivered to the Project Site. Risk and title will pass from the Supplier to the Procuring Entity upon receipt and final acceptance of the Goods at their final destination. ”</p> <p>The delivery terms applicable to this Contract are delivered to:</p> <p>Philippine National Oil Company  PNOC Bldg. 6, Energy Center, Rizal Drive, BGC, Taguig City</p> <p>Delivery of the Goods shall be made by the Supplier in accordance with the terms specified in Section VI (Schedule of Requirements).</p> <p>For purposes of this Clause the Procuring Entity’s Representative at the Project Site is:</p> <p style="text-align: center;">Atty. Maria Francheska M. Garcia  Head Executive Assistant</p> <p><b>Incidental Services –</b></p> <p>The Supplier is required to provide all of the following services, including additional services, if any, specified in Section VI. Schedule of Requirements:</p> <ol style="list-style-type: none"> <li>a. performance or supervision of on-site assembly and/or start-up of the supplied Goods;</li> <li>b. furnishing of tools required for assembly and/or maintenance of the supplied Goods;</li> <li>c. furnishing of a detailed operations and maintenance manual for each appropriate unit of the supplied Goods;</li> <li>d. performance or supervision or maintenance and/or repair of the supplied Goods, for a period of time agreed by the parties, provided that this service shall not relieve the Supplier of any warranty obligations under this Contract; and</li> </ol>
	<ol style="list-style-type: none"> <li>e. training of the Procuring Entity’s personnel, at the Supplier’s plant and/or on-site, in assembly, start-up, operation, maintenance, and/or repair of the supplied Goods.</li> </ol>

The Contract price for the Goods shall include the prices charged by the Supplier for incidental services and shall not exceed the prevailing rates charged to other parties by the Supplier for similar services.

**Spare Parts –**

The Supplier is required to provide all of the following materials, notifications, and information pertaining to spare parts manufactured or distributed by the Supplier:

- a. such spare parts as the Procuring Entity may elect to purchase from the Supplier, provided that this election shall not relieve the Supplier of any warranty obligations under this Contract; and
- b. in the event of termination of production of the spare parts:
  - i. advance notification to the Procuring Entity of the pending termination, in sufficient time to permit the Procuring Entity to procure needed requirements; and
  - ii. following such termination, furnishing at no cost to the Procuring Entity, the blueprints, drawings, and specifications of the spare parts, if requested.

The spare parts and other components required are listed in **Section VI (Schedule of Requirements)** and the cost thereof are included in the contract price.

The Supplier shall carry sufficient inventories to assure ex-stock supply of consumable spare parts or components for the Goods for a period of **one (1) year**.

Spare parts or components shall be supplied as promptly as possible, but in any case, within **one (1) month** of placing the order.

**Packaging –**

The Supplier shall provide such packaging of the Goods as is required to prevent their damage or deterioration during transit to their final destination, as indicated in this Contract. The packaging shall be sufficient to withstand, without limitation, rough handling during transit and exposure to extreme temperatures, salt and precipitation during transit, and open storage. Packaging case size and weights shall take into consideration, where appropriate, the remoteness of the Goods' final destination and the absence of heavy handling facilities at all points in transit.



The packaging, marking, and documentation within and outside the packages shall comply strictly with such special requirements as shall be expressly provided for in the Contract, including additional requirements, if any, specified below, and in any subsequent instructions ordered by the Procuring Entity.

The outer packaging must be clearly marked on at least four (4) sides as follows:

- Name of the Procuring Entity
- Name of the Supplier
- Contract Description
- Final Destination
- Gross weight
- Any special lifting instructions
- Any special handling instructions
- Any relevant HAZCHEM classifications

A packaging list identifying the contents and quantities of the package is to be placed on an accessible point of the outer packaging if practical. If not practical the packaging list is to be placed inside the outer packaging but outside the secondary packaging.

**Transportation –**

Where the Supplier is required under Contract to deliver the Goods CIF, CIP, or DDP, transport of the Goods to the port of destination or such other named place of destination in the Philippines, as shall be specified in this Contract, shall be arranged and paid for by the Supplier, and the cost thereof shall be included in the Contract Price.

Where the Supplier is required under this Contract to transport the Goods to a specified place of destination within the Philippines, defined as the Project Site, transport to such place of destination in the Philippines, including insurance and storage, as shall be specified in this Contract, shall be arranged by the Supplier, and related costs shall be included in the contract price.

Where the Supplier is required under Contract to deliver the Goods CIF, CIP or DDP, Goods are to be transported on carriers of Philippine registry. In the event that no carrier of Philippine registry is available, Goods may be shipped by a carrier which is not of Philippine registry provided that the Supplier obtains and presents to the Procuring Entity certification to this effect from the nearest Philippine consulate to the port of dispatch. In the event that carriers of Philippine registry are available but their schedule delays the Supplier in its performance of this Contract the period from when the Goods were first ready for shipment and the actual date of shipment the period of delay will be considered force majeure.

The Procuring Entity accepts no liability for the damage of Goods during transit other than those prescribed by INCOTERMS for DDP deliveries. In the case of Goods supplied from within the Philippines or supplied by domestic

Suppliers risk and title will not be deemed to have passed to the Procuring Entity until their receipt and final acceptance at the final destination.

**Intellectual Property Rights –**

The Supplier shall indemnify the Procuring Entity against all third-party claims of infringement of patent, trademark, or industrial design rights arising from use of the Goods or any part thereof.

2.2	No further instructions
4	The inspections and tests that will be conducted are those indicated in Sec. VII. Technical Specifications (if applicable)



## *Section VI. Schedule of Requirements*

The delivery schedule expressed as weeks/months stipulates hereafter a delivery date which is the date of delivery to the project site.

ITEM NO.	DESCRIPTION	QTY/ UOM	Delivery Schedule
1	<b>3-Seater Sofa (President's Office)</b>	1 unit	Within sixty (60) calendars days upon receipt of the Purchase Order
2	<b>3- Seater Sofa (OP Lounge)</b>	1 unit	
3	<b>Conference Table</b>	2 units	
4	<b>6-Pax Work Station (table)</b>	2 units	
5	<b>1-Seater Sofa (President's Office &amp; Lounge)</b>	5 units	
6	<b>1-Seater Chair</b>	4 units	
7	<b>Office Chair</b>	18 units	
8	<b>Lateral Filing Cabinet (4-Layers)</b>	4 units	
9	<b>Vertical Filing Cabinet (4-Layers)</b>	3 units	
10	<b>Mobile Pedestal</b>	12 units	
11	<b>2-Seater Coffee Table Set</b>	3 units	
12	<b>14- 16 Seater "U" Type Conference Table</b>	1 unit	
13	<b>Podium Stand with storage shelf</b>	1 unit	
14	<b>3- Seater Sofa</b>	1 unit	
15	<b>Executive Chair</b>	40 units	
16	<b>1- Seater Sofa (Lounge)</b>	2 units	

Name of Company: \_\_\_\_\_

Authorized Representative: \_\_\_\_\_  
(Name and Signature)

## ***Section VII. Technical Specifications***



## Technical Specifications

Bidders must state here either “Comply” or “Not Comply” against each of the individual parameters of each Specification stating the corresponding performance parameter of the equipment offered. Statements of “Comply” or “Not Comply” must be supported by evidence in a Bidders Bid and cross-referenced to that evidence. **Evidence shall be in the form of manufacturer’s un-amended sales literature, unconditional statements of specification and compliance issued by the manufacturer, samples, independent test data etc., as appropriate. A statement that is not supported by evidence or is subsequently found to be contradicted by the evidence presented will render the Bid under evaluation liable for rejection.** A statement either in the Bidder's statement of compliance or the supporting evidence that is found to be false either during Bid evaluation, post-qualification or the execution of the Contract may be regarded as fraudulent and render the Bidder or supplier liable for prosecution subject to the applicable laws and issuances.

ITEM NO.	DESCRIPTION	QTY/ UOM	Statement of Compliance
1	<p><b>3-Seater Sofa (President’s Office)</b></p> <ul style="list-style-type: none"> <li>- Dimension: 2.08m (L) x0.91m (D) x 0.75m overall(H)</li> <li>- Seat height: 0.45m (H)</li> <li>- Arm rest height: 0.60m (H)</li> <li>- High density foam seat &amp; cushion back &amp; arm rest in light beige chenille fabric or leather</li> <li>- With Mahogany wood frame &amp; legs</li> </ul> <p><i>(Please refer to attached (Annex “A”) photo for design and dimension reference. Bidder to provide at least 3 samples of fabric for approval)</i></p>	1 unit	
2	<p><b>3- Seater Sofa (OP Lounge)</b></p> <ul style="list-style-type: none"> <li>- Dimension: 1.80m (L) x0.75m (D) x 0.75m (H)</li> <li>- Seat height: 0.45m (H)</li> <li>- High density foam in cream/beige polyester fabric</li> <li>- With Mahogany wood or rubber wood frame &amp; legs</li> </ul> <p><i>(Please refer to attached photo (Annex “A”) for design and dimension reference. Bidder to provide at least 3 samples of fabric for approval)</i></p>	1 unit	
3	<p><b>Conference Table</b></p> <ul style="list-style-type: none"> <li>- Table dimension: 2.40m (L) x 1.20m (W) x 0.75m (H)</li> <li>- E1-grade MFC board with Light oak laminate finish</li> <li>- Melamine frame &amp; support</li> <li>- With adjustable feet leveler</li> <li>- Middle support for wire management</li> </ul> <p><i>(Please refer to attached photo (Annex “A”) for design reference)</i></p>	2 units	
4	<p><b>6-Pax Work station (table)</b></p>	2 units	



	<ul style="list-style-type: none"> <li>- Table dimension: 3.60m (L) x 1.20m (W) x 0.75m (H)</li> <li>- E1 MFC board with light brown laminate finish</li> <li>- Durable molded steel frame with light brown powder coating</li> </ul> <p><i>(Please refer to attached photo (Annex "A") for design reference)</i></p>		
5	<p><b>1-Seater Sofa (President's Office &amp; Lounge)</b></p> <ul style="list-style-type: none"> <li>- Dimension: 75m (L) x 0.71m (D) x 0.75m overall(H)</li> <li>- Seat height: 0.45m (H)</li> <li>- High density foam seat &amp; cushion back &amp; arm rest in light beige chenille fabric or leather</li> <li>- With Mahogany wood frame &amp; legs</li> </ul> <p><i>(Please refer to attached photo (Annex "A") for design and dimension reference. Bidder to provide at least 3 samples of fabric for approval)</i></p>	5 units	
6	<p><b>1-Seater Chair</b></p> <ul style="list-style-type: none"> <li>- Chair dimension: 0.60m (L) x 0.50m (D) x 0.85m over all height</li> <li>- Seat height: 0.45m (H)</li> <li>- High density foam seat &amp; cushion back &amp; arm rest in light beige chenille fabric</li> <li>- Tanguile wood in light walnut finish arm rest and legs</li> </ul> <p><i>(Please refer to attached photo (Annex "A") for design reference only)</i></p>	4 units	
7	<p><b>Office Chair</b></p> <ul style="list-style-type: none"> <li>- Highback Chair with arm &amp; rest</li> <li>- Adjustable gaslift with tilting mechanism, soft-thread leather upholstery</li> <li>- Steel legs in chrome finish with castor wheels</li> </ul> <p><i>(Please refer to attached photo (Annex "A") for design reference only)</i></p>	18 units	
8	<p><b>Lateral Filing Cabinet (4-Layers)</b></p> <ul style="list-style-type: none"> <li>- Cabinet dimension: 0.90m (L) x 0.45m (D) x 1.30m (H)</li> <li>- Gold sides &amp; white drawer: Powder coated finish</li> <li>- Flush handle</li> </ul> <p><i>(Please refer to attached photo (Annex "A") for design reference only. Supplier may propose color similar to the given dimension for approval)</i></p>	4 units	
9	<p><b>Vertical Filing Cabinet (4-Layers)</b></p> <ul style="list-style-type: none"> <li>- Approx. cabinet dimension: 0.46m (L) x 0.62m (D) x 1.30m (H)</li> <li>- Gold sides &amp; white drawer: Powder coated finish</li> <li>- Flush handle</li> </ul> <p><i>(Please refer to attached photo (Annex "A") for design reference only. Supplier may propose color similar to the given dimension for approval)</i></p>	3 units	



10	<p><b>Mobile Pedestal</b></p> <ul style="list-style-type: none"> <li>- Approx. pedestal dimension: 0.40m (W) x 0.56m (D) x 0.65m (H)</li> <li>- White or beige powder coated finish</li> <li>- Flush handle</li> <li>- With castor wheels</li> </ul> <p><i>(Please refer to attached photo (Annex "A") for design reference only)</i></p>	12 units	
11	<p><b>2-Seater Coffee Table (Set)</b></p> <ul style="list-style-type: none"> <li>- Table height: 0.70m (H)</li> <li>- Tempered glass top: Diameter .50m (dia)</li> <li>- Chair seat height 0.45m (H)</li> </ul> <p><i>(Please refer to attached photo (Annex "A") for design reference only. Supplier may propose set of coffee table set for approval)</i></p>	3 units	
12	<p><b>14- 16 Seater "U" Type Conference Table</b></p> <ul style="list-style-type: none"> <li>- Left &amp; Right Table Dimension: 4.20m (L)x 0.6m (W) x 0.75m (H)</li> <li>- Center Table Dimension: 3.60m (L) x 0.6m (W) x 0.75m (H)</li> <li>- 25mm THK. Laminated HDF board top with edge band (Light oak/ Classic Chesnut/ Dark Ash wood finish)</li> <li>- Black 1" x3" steel legs powder coated black</li> <li>- With adjustable feet leveler</li> <li>- With rectangular grommet for wire management</li> </ul> <p><i>(Please refer to attached photo (Annex "A") for design &amp; dimension reference. Supplier to provide at least 3 samples of finish for approval)</i></p>	1 unit	
13	<p><b>Podium Stand with storage shelf</b></p> <ul style="list-style-type: none"> <li>- Dimension: 0.60m (W) x0.40m (L) x 1.20 highest point 1.10m(H)</li> <li>- ½" THK. Clear acrylic material</li> </ul> <p><i>(Please refer to attached photo (Annex "A") for design and dimension reference)</i></p>	1 unit	
14	<p><b>3- Seater Sofa</b></p> <ul style="list-style-type: none"> <li>- Dimension: 1.80m (L) x0.75m (D) x 0.75m (H)</li> <li>- Seat height: 0.45m (H)</li> <li>- High density foam in cream/beige polyester fabric</li> <li>- With Mahogany wood or rubber wood frame &amp; legs</li> </ul> <p><i>(Please refer to attached photo (Annex "A") for design and dimension reference. Bidder to provide at least 3 samples of fabric for approval)</i></p>	1 unit	
15	<p><b>Executive Chair</b></p> <ul style="list-style-type: none"> <li>- Executive Highback Chair with arm &amp; head rest</li> <li>- Mesh back rest</li> <li>- Adjustable gaslift with tilting mechanism, soft-thread leather upholstery</li> </ul>	40 units	

	<ul style="list-style-type: none"> <li>- Steel legs in chrome finish with castor wheels</li> </ul> <i>(Please refer to attached photo (Annex "A") for design reference only)</i>		
16	<p><b>1- Seater Sofa (Lounge)</b></p> <ul style="list-style-type: none"> <li>- Dimension: 0.75m (L) x0.71m (D) x 0.75m (H)</li> <li>- Seat height: 0.45m (H)</li> <li>- High density foam seat &amp; cushion back &amp; arm rest in light beige chenille fabric or leather</li> <li>- With Mahogany wood frame legs</li> </ul> <i>(Please refer to attached photo (Annex "A") for design and dimension reference. Bidder to provide at least 3 samples of fabric for approval)</i>	2 units	

Name of Company: \_\_\_\_\_

Authorized Representative: \_\_\_\_\_  
(Name & Signature)



***Section VIII. Checklist of Technical and  
Financial Documents***

# Checklist of Technical and Financial Documents

## I. TECHNICAL COMPONENT ENVELOPE

### *Class "A" Documents*

#### Legal Documents

- (a) Valid PhilGEPS Registration Certificate (Platinum Membership) (all pages) in accordance with Section 8.5.2 of the IRR;

#### Technical Documents

- (b) Statement of the prospective bidder of all its ongoing government and private contracts, including contracts awarded but not yet started, if any, whether similar or not similar in nature and complexity to the contract to be bid; **and**
- (c) Statement of the bidder's Single Largest Completed Contract (SLCC) similar to the contract to be bid, except under conditions provided for in Sections 23.4.1.3 and 23.4.2.4 of the 2016 revised IRR of RA No. 9184, within the relevant period as provided in the Bidding Documents; **and**
- (d) Original copy of Bid Security. If in the form of a Surety Bond, submit also a certification issued by the Insurance Commission;  
**or**  
Original copy of Notarized Bid Securing Declaration; **and**
- (e) Conformity with the Technical Specifications, which may include production/delivery schedule, manpower requirements, and/or after-sales/parts, if applicable; **and**
- (f) Original duly signed Omnibus Sworn Statement (OSS); **and** if applicable, Original Notarized Secretary's Certificate in case of a corporation, partnership, or cooperative; or Original Special Power of Attorney of all members of the joint venture giving full power and authority to its officer to sign the OSS and do acts to represent the Bidder.
- (g) At least 3 samples of fabric (fabric swatches) for approval for the following items:
1. 3-Seater Sofa (President's Office)(item
  2. 3- Seater Sofa (OP Lounge)
  5. 1-Seater Sofa (President's Office & Lounge)
  14. 3- Seater Sofa
  16. 1- Seater Sofa (Lounge)

#### Financial Documents

- (k) The prospective bidder's computation of Net Financial Contracting Capacity (NFCC);  
**or**  
A committed Line of Credit from a Universal or Commercial Bank in lieu of its NFCC computation.

### *Class "B" Documents*

- (l) If applicable, a duly signed joint venture agreement (JVA) in case the joint venture is already in existence;  
**or**  
duly notarized statements from all the potential joint venture partners stating that they will enter into and abide by the provisions of the JVA in the instance that the bid is successful.



Other documentary requirements under RA No. 9184 (as applicable)

- (m) *[For foreign bidders claiming by reason of their country's extension of reciprocal rights to Filipinos]* Certification from the relevant government office of their country stating that Filipinos are allowed to participate in government procurement activities for the same item or product.
- (n) Certification from the DTI if the Bidder claims preference as a Domestic Bidder or Domestic Entity.

**25 FINANCIAL COMPONENT ENVELOPE**

- (a) Original of duly signed and accomplished Financial Bid Form; **and**
- (b) Original of duly signed and accomplished Price Schedule(s).

## ***Section IX. Bidding Forms***



**STATEMENT OF SINGLE LARGEST COMPLETED CONTRACT SIMILAR TO THE CONTRACT TO BE BID**

This is to certify that (Bidder) has completed the below-listed contract within **five (5)** years prior the deadline of submission and opening of bids.

Date of the Contract	Contracting Party	Name of Contract	Nature of Contract	Amount of Contract	Contract Duration	Issuance Date of Certification Satisfactory Service

\_\_\_\_\_  
Name and Signature of Authorized Representative

\_\_\_\_\_  
Date

\*Notes:

- a) Cut-off date as of **DEADLINE OF SUBMISSION OF BIDS.**
- b) "Name of Contract". Indicate here the Nature/ Scope of the Contract for the Procuring Entity to determine the relevance of the entry with the Procurement at hand.





## BID FORM

Date : \_\_\_\_\_  
Project Identification No.: \_\_\_\_\_

To: *[name and address of Procuring Entity]*

Having examined the Philippine Bidding Documents (PBDs) including the Supplemental or Bid Bulletin Numbers *[insert numbers]*, the receipt of which is hereby duly acknowledged, we, the undersigned, offer to *[supply/deliver/perform]* *[description of the Goods/Services]* in conformity with the said PBDs for the sum of *[total Bid amount in words and figures]* or the total calculated bid price, as evaluated and corrected for computational errors, and other bid modifications in accordance with the Price Schedules attached herewith and made part of this Bid. The total bid price includes the cost of all taxes, such as, but not limited to: *[specify the applicable taxes, e.g. (i) value added tax (VAT), (ii) income tax, (iii) local taxes, and (iv) other fiscal levies and duties]*, which are itemized herein or in the Price Schedules,

If our Bid is accepted, we undertake:

- a. To deliver the goods in accordance with the delivery schedule specified in the Schedule of Requirements of the Philippine Bidding Documents(PBDs);
- b. To provide a performance security in the form, amounts, and within the times prescribed in the PBDs;
- c. to abide by the Bid Validity Period specified in the PBDs and it shall remain binding upon us at any time before the expiration of that period.

Until a formal Contract is prepared and executed, this Bid, together with your written acceptance thereof and your Notice of Award, shall be binding upon us.

We understand that you are not bound to accept the Lowest Calculated Bid or any Bid you may receive.

We certify/confirm that we comply with the eligibility requirements pursuant to the PBDs.

The undersigned is authorized to submit the bid on behalf of *[name of the bidder]* as evidenced by the attached *[state the written authority]*.

We acknowledge that failure to sign each and every page of this Bid Form, including the attached Schedule of Prices, shall be a ground for the rejection of our bid.

Name of Authorized Representative: \_\_\_\_\_

Legal capacity: \_\_\_\_\_ Signature: \_\_\_\_\_

Duly authorized to sign the Bid for and behalf of: \_\_\_\_\_

Date: \_\_\_\_\_

**Price Schedule for Goods Offered from Within the Philippines**

1	2	3	4	5	6	7	8	9	10
Item	Description	Country of Origin	Quantity	Unit Price EXW per item	Transportation and all other costs incidental to delivery, per item	Sales and other taxes payable if Contract is awarded, per item	Cost of Incidental Services, if applicable, per item	Total Price, per unit  (col 5+6+7+8)	Total Price delivered Final Destination  (col 9) x (col 4)

Name: \_\_\_\_\_

Legal Capacity: \_\_\_\_\_

Signature: \_\_\_\_\_

Duly authorized to sign the Bid for and behalf of: \_\_\_\_\_



**Price Schedule for Goods Offered from Abroad**

1	2	3	4	5	6	7	8	9
Item	Description	Country of Origin	Quantity	Unit price CIF port of entry (specify port) or CIP named place (specify border point or place of destination)	Total CIF or CIP price per item (col 4x5)	Unit Price Delivered Duty Unpaid (DDU)	Unit price Delivered Duty Paid (DDP)	Total Price delivered DDP (col 4x8)

Name: \_\_\_\_\_

Legal Capacity: \_\_\_\_\_

Signature: \_\_\_\_\_

Duly authorized to sign the Bid for and behalf of: \_\_\_\_\_

REPUBLIC OF THE PHILIPPINES)  
CITY OF \_\_\_\_\_)S.S.

## BID SECURING DECLARATION

Project Identification No.: *[Insert number]*

To: *[Insert name and address of the Procuring Entity]*

I/We, the undersigned, declare that:

1. I/We understand that, according to your conditions, bids must be supported by a Bid Security, which may be in the form of a Bid Securing Declaration.
2. I/We accept that: (a) I/we will be automatically disqualified from bidding for any procurement contract with any procuring entity for a period of two (2) years upon receipt of your Blacklisting Order; and, (b) I/we will pay the applicable fine provided under Section 6 of the Guidelines on the Use of Bid Securing Declaration, within fifteen (15) days from receipt of the written demand by the procuring entity for the commission of acts resulting to the enforcement of the bid securing declaration under Sections 23.1(b), 34.2, 40.1 and 69.1, except 69.1(f), of the IRR of RA No. 9184; without prejudice to other legal action the government may undertake.
3. I/We understand that this Bid Securing Declaration shall cease to be valid on the following circumstances:
  - a. Upon expiration of the bid validity period, or any extension thereof pursuant to your request;
  - b. I am/we are declared ineligible or post-disqualified upon receipt of your notice to such effect, and (i) I/we failed to timely file a request for reconsideration or (ii) I/we filed a waiver to avail of said right; and
  - c. I am/we are declared the bidder with the Lowest Calculated Responsive Bid, and I/we have furnished the performance security and signed the Contract.

IN WITNESS WHEREOF, I/We have hereunto set my/our hand/s this \_\_\_\_\_ day of *[month]* *[year]* at *[place of execution]*.

*[Insert NAME OF BIDDER OR ITS  
AUTHORIZED REPRESENTATIVE]  
[Insert signatory's legal capacity]  
Affiant*

**SUBSCRIBED AND SWORN** to before me this \_\_\_\_ day of *[month]* *[year]* at *[place of execution]*, Philippines. Affiant/s is/are personally known to me and was/were identified by me through competent evidence of identity as defined in the 2004 Rules on Notarial Practice (A.M. No. 02-8-13-SC). Affiant/s exhibited to me his/her insert type of government identification card



used], with his/her photograph and signature appearing thereon, with no. \_\_\_\_\_ issued on \_\_\_\_\_ at \_\_\_\_\_.

Witness my hand and seal this \_\_\_\_ day of *[month]* *[year]*.

**NAME OF NOTARY PUBLIC**

Serial No. of Commission \_\_\_\_\_

Notary Public for \_\_\_\_\_ until \_\_\_\_\_

Roll of Attorneys No. \_\_\_\_\_

PTR No. \_\_\_\_\_ *[date issued]*, *[place issued]*

IBP No. \_\_\_\_\_ *[date issued]*, *[place issued]*

Doc. No. \_\_\_\_\_

Page No. \_\_\_\_\_

Book No. \_\_\_\_\_

Series of \_\_\_\_\_

## CONTRACT AGREEMENT

THIS AGREEMENT made the day of \_\_\_\_\_ 20\_\_\_\_ between [name of PROCURING ENTITY] of the Philippines (hereinafter called “the Entity”) of the one part and [name of Supplier] of [city and country of Supplier] (hereinafter called “the Supplier/Service Provider”) of the other part;

WHEREAS, the Entity invited Bids for certain goods and ancillary services, particularly [brief description of goods and services] and has accepted a Bid by the Supplier for the supply of those goods and services in the sum of [contract price in words and figures in specified currency] (hereinafter called “the Contract Price”).

NOW THIS AGREEMENT WITNESSETH AS FOLLOWS:

1. In this Agreement words and expressions shall have the same meanings as are respectively assigned to them in the Conditions of Contract referred to.
2. The following documents as required by the 2016 revised Implementing Rules and Regulations of Republic Act No. 9184 shall be deemed to form and be read and construed as integral part of this Agreement, viz.:
  - i. Philippine Bidding Documents(PBDs);
    - i. Schedule of Requirements;
    - ii. Technical Specifications;
    - iii. General and Special Conditions of Contract; and
    - iv. Supplemental or Bid Bulletins, if any
  - ii. Winning bidder’s bid, including the Eligibility requirements, Technical and Financial Proposals, and all other documents or statements submitted;  
  
Bid form, including all the documents/statements contained in the Bidder’s bidding envelopes, as annexes, and all other documents submitted (e.g., Bidder’s response to request for clarifications on the bid), including corrections to the bid, if any, resulting from the Procuring Entity’s bid evaluation;
  - iii. Performance Security;
  - iv. Notice of Award of Contract; and the Bidder’s conforme thereto; and
  - v. Other contract documents that maybe required by existing laws and/or the Procuring Entity concerned in the PBDs. **Winning bidder agrees that additional contract documents or information prescribed by the GPPB that are subsequently required for submission after the contract execution, such as the Notice to Proceed, Variation Orders, and Warranty Security, shall likewise form part of the Contract.**
3. In consideration for the sum of [total contract price in words and figures] or such other sums as may be ascertained, [Named of the bidder] agrees to [state the object of the contract] in accordance with his/her/its Bid.



4. The *[Name of the procuring entity]* agrees to pay the above-mentioned sum in accordance with the terms of the Bidding.

IN WITNESS whereof the parties hereto have caused this Agreement to be executed in accordance with the laws of the Republic of the Philippines on the day and year first above written.

**For the Entity:**  
By

**For the Supplier/Service Provider**  
By:

---

President and  
Chief Executive Officer

---

*Insert Name of Signatory*  
*Insert Legal Capacity of the Signatory*

Witnesses

---

REPUBLIC OF THE PHILIPPINES ) S.S.  
CITY OF \_\_\_\_\_ )

**ACKNOWLEDGMENT**

Before me, a notary public for and in the City of \_\_\_\_\_, this \_\_\_\_\_, personally appeared the following:

Name	Competent Evidence of Identity	Date/Place Issued

Known to me to be the same persons who executed the foregoing Contract Agreement consisting of three (3) pages, including the page on which this Acknowledgment is written, but excluding Annexes, and they acknowledged to me that the same is their free and voluntary act and deed, as well as that of their respective principals.

WITNESS MY HAND AND SEAL, on the date and in the place first above written.

Doc. No. \_\_\_\_\_  
Page No. \_\_\_\_\_  
Book No. \_\_\_\_\_  
Series of \_\_\_\_\_



## **OMNIBUS SWORN STATEMENT**

REPUBLIC OF THE PHILIPPINES )  
CITY/MUNICIPALITY OF \_\_\_\_\_)S.S.

### **AFFIDAVIT**

I, [Name of Affiant], of legal age, [Civil Status], [Nationality], and residing at [Address of Affiant], after having been duly sworn in accordance with law, do hereby depose and state that:

1. *[Select one, delete the other:]*

*[If a sole proprietorship:]* I am the sole proprietor or authorized representative of [Name of Bidder] with office address at [address of Bidder];

*[If a partnership, corporation, cooperative, or joint venture:]* I am the duly authorized and designated representative of [Name of Bidder] with office address at [address of Bidder];

2. *[Select one, delete the other:]*

*[If a sole proprietorship:]* As the owner and sole proprietor, or authorized representative of [Name of Bidder], I have full power and authority to do, execute and perform any and all acts necessary to participate, submit the bid, and to sign and execute the ensuing contract for [Name of the Project] of the [Name of the Procuring Entity], as shown in the attached duly notarized Special Power of Attorney;

*[If a partnership, corporation, cooperative, or joint venture:]* I am granted full power and authority to do, execute and perform any and all acts necessary to participate, submit the bid, and to sign and execute the ensuing contract for [Name of the Project] of the [Name of the Procuring Entity], as shown in the attached [state title of attached document showing proof of authorization (e.g., duly notarized Secretary's Certificate, Board/Partnership Resolution, or Special Power of Attorney, whichever is applicable)];

3. [Name of Bidder] is not "blacklisted" or barred from bidding by the Government of the Philippines or any of its agencies, offices, corporations, or Local Government Units, foreign government/foreign or international financing institution whose blacklisting rules have been recognized by the Government Procurement Policy Board, **by itself or by relation, membership, association, affiliation, or controlling interest with another blacklisted person or entity as defined and provided for in the Uniform Guidelines on Blacklisting;**

4. Each of the documents submitted in satisfaction of the bidding requirements is an authentic copy of the original, complete, and all statements and information provided therein are true and correct;

5. [Name of Bidder] is authorizing the Head of the Procuring Entity or its duly authorized representative(s) to verify all the documents submitted;

6. *[Select one, delete the rest:]*

*[If a sole proprietorship:]* The owner or sole proprietor is not related to the Head of the Procuring Entity, members of the Bids and Awards Committee (BAC), the Technical



Working Group, and the BAC Secretariat, the head of the Project Management Office or the end-user unit, and the project consultants by consanguinity or affinity up to the third civil degree;

*[If a partnership or cooperative:]* None of the officers and members of *[Name of Bidder]* is related to the Head of the Procuring Entity, members of the Bids and Awards Committee (BAC), the Technical Working Group, and the BAC Secretariat, the head of the Project Management Office or the end-user unit, and the project consultants by consanguinity or affinity up to the third civil degree;

*[If a corporation or joint venture:]* None of the officers, directors, and controlling stockholders of *[Name of Bidder]* is related to the Head of the Procuring Entity, members of the Bids and Awards Committee (BAC), the Technical Working Group, and the BAC Secretariat, the head of the Project Management Office or the end-user unit, and the project consultants by consanguinity or affinity up to the third civil degree;

7. *[Name of Bidder]* complies with existing labor laws and standards; and
8. *[Name of Bidder]* is aware of and has undertaken the responsibilities as a Bidder in compliance with the Philippine Bidding Documents, which includes:
  - a. Carefully examining all of the Bidding Documents;
  - b. Acknowledging all conditions, local or otherwise, affecting the implementation of the Contract;
  - c. Making an estimate of the facilities available and needed for the contract to be bid, if any; and
  - d. Inquiring or securing Supplemental/Bid Bulletin(s) issued for the *[Name of the Project]*.
9. *[Name of Bidder]* did not give or pay directly or indirectly, any commission, amount, fee, or any form of consideration, pecuniary or otherwise, to any person or official, personnel or representative of the government in relation to any procurement project or activity.
10. *[Name of Bidder]* hereby assigns the following contact number/s and e-mail address/es as the official telephone/fax number and contact reference of the company where the PROCURING ENTITY notices may be transmitted.

Telephone No/s. : \_\_\_\_\_  
Fax No/s. : \_\_\_\_\_  
E-mail Add/s. : \_\_\_\_\_

It is understood that notices/s transmitted in the above-stated telephone/fax numbers and/or e-mail address/es are deemed received as of its transmittal and the reckoning period for the reglementary periods stated in the bidding documents and the revised Implementing Rules and Regulations of Republic Act No. 9184 shall commence from receipt thereof.

11. **In case advance payment was made or given, failure to perform or deliver any of the obligations and undertakings in the contract shall be sufficient grounds to constitute criminal liability for Swindling (Estafa) or the commission of fraud with unfaithfulness or abuse of confidence through misappropriating or converting any payment received by a person or entity under an obligation involving the duty to deliver certain goods or services, to the prejudice of the public and the government of the Philippines pursuant to Article 315 of Act No. 3815 s. 1930, as amended, or the Revised Penal Code.**

IN WITNESS WHEREOF. I have hereunto set my hand this \_\_\_\_\_ day of \_\_\_\_\_, 20\_\_ at



\_\_\_\_\_, Philippines.

*[Insert NAME OF BIDDER OR ITS AUTHORIZED REPRESENTATIVE]*

*[Insert signatory's legal capacity]*

Affiant

**SUBSCRIBED AND SWORN** to before me this \_\_\_\_ day of *[month]* *[year]* at *[place of execution]*, Philippines. Affiant/s is/are personally known to me and was/were identified by me through competent evidence of identity as defined in the 2004 Rules on Notarial Practice (A.M. No. 02-8-13-SC). Affiant/s exhibited to me his/her insert type of government identification card used, with his/her photograph and signature appearing thereon, with no. \_\_\_\_\_ issued on \_\_\_\_ at \_\_\_\_\_.

Witness my hand and seal this \_\_\_\_ day of *[month]* *[year]*.

**NAME OF NOTARY PUBLIC**

Serial No. of Commission \_\_\_\_\_

Notary Public for \_\_\_\_\_ until \_\_\_\_\_

Roll of Attorneys No. \_\_\_\_\_

PTR No. \_\_\_\_\_ *[date issued]*, *[place issued]*

IBP No. \_\_\_\_\_ *[date issued]*, *[place issued]*

Doc. No. \_\_\_\_\_

Page No. \_\_\_\_\_

Book No. \_\_\_\_\_

Series of \_\_\_\_\_

REPUBLIC OF THE PHILIPPINES)  
CITY OF \_\_\_\_\_ ) S.S.

NAME OF NOTARY PUBLIC  
Serial No. of Commission  
Notary Public for \_\_\_\_\_ until \_\_\_\_\_  
Roll of Attorneys No. \_\_\_\_\_  
[Notary Seal]

### PERFORMANCE SECURING DECLARATION

Invitation to Bid: [Insert Reference Number indicated in the Bidding Documents]  
To: [Insert name and address of the Procuring Entity]

I/We, the undersigned, declare that:

1. I/We understand that, according to your conditions, to guarantee the faithful performance by the supplier/distributor/manufacturer/contractor/consultant of its obligations under the Contract, I/we shall submit a Performance Securing Declaration within a maximum period of ten (10) calendar days from the receipt of the Notice of Award prior to the signing of the Contract.
2. I/We accept that: I/we will be automatically disqualified from bidding for any procurement contract with any procuring entity for a period of one (1) year for the first offense, or two (2) years **for the second offense**, upon receipt of your Blacklisting Order if I/We have violated my/our obligations under the Contract;
3. I/We understand that this Performance Securing Declaration shall cease to be valid upon:
  - a. issuance by the Procuring Entity of the Certificate of Final Acceptance, subject to the following conditions:
    - i. Procuring Entity has no claims filed against the contract awardee;
    - ii. It has no claims for labor and materials filed against the contractor; and
    - iii. Other terms of the contract; or
  - b. replacement by the winning bidder of the submitted PSD with a performance security in any of the prescribed forms under Section 39.2 of the 2016 revised IRR of RA No. 9184 as required by the end-user.

IN WITNESS WHEREOF, I/We have hereunto set my/our hand/s this \_\_\_\_\_ day of [month] [year] at [place of execution].

[Insert NAME OF BIDDER OR ITS  
AUTHORIZED REPRESENTATIVE]  
[Insert signatory's legal capacity]  
Affiant

**SUBSCRIBED AND SWORN** to before me this \_\_\_ day of [month] [year] at [place of execution], Philippines. Affiant/s is/are personally known to me and was/were identified by me through competent evidence of identity as defined in the 2004 Rules on Notarial Practice (A.M. No. 02-8-13-SC). Affiant/s exhibited to me his/her [insert type of government identification card used], with his/her photograph and signature appearing thereon, with no. \_\_\_\_\_ issued on \_\_\_\_\_ at \_\_\_\_\_.

Witness my hand and seal this \_\_\_ day of [month] [year].



**NAME OF NOTARY PUBLIC**

Serial No. of Commission \_\_\_\_\_

Notary Public for \_\_\_\_\_ until \_\_\_\_\_

Roll of Attorneys No. \_\_\_\_\_

PTR No. \_\_\_\_\_ *[date issued], [place issued]*

IBP No. \_\_\_\_\_ *[date issued], [place issued]*

Doc. No. \_\_\_\_\_

Page No. \_\_\_\_\_

Book No. \_\_\_\_\_

Series of \_\_\_\_\_

## NET FINANCIAL CONTRACTING CAPACITY

Current Assets

\_\_\_\_\_

**Less: Current Liabilities**

\_\_\_\_\_

Total

\_\_\_\_\_

Multiply by K

**15**

Total

\_\_\_\_\_

**Less: Value of All Outstanding Works or  
Projects Under On-going Contracts**

\_\_\_\_\_

**Net Financial Contracting Capacity**

=====

---

Net Financial Contracting Capacity (NFCC)

**NFCC = at least equal to the Approved Budget**

= [(current assets - current liabilities) (K) - (value of all outstanding works or projects under on-going contracts, including awarded contracts yet to be started)]

Name of Company:

\_\_\_\_\_

Authorized Representative:

\_\_\_\_\_

signature over printed name



Republic of the Philippines



Government Procurement Policy Board

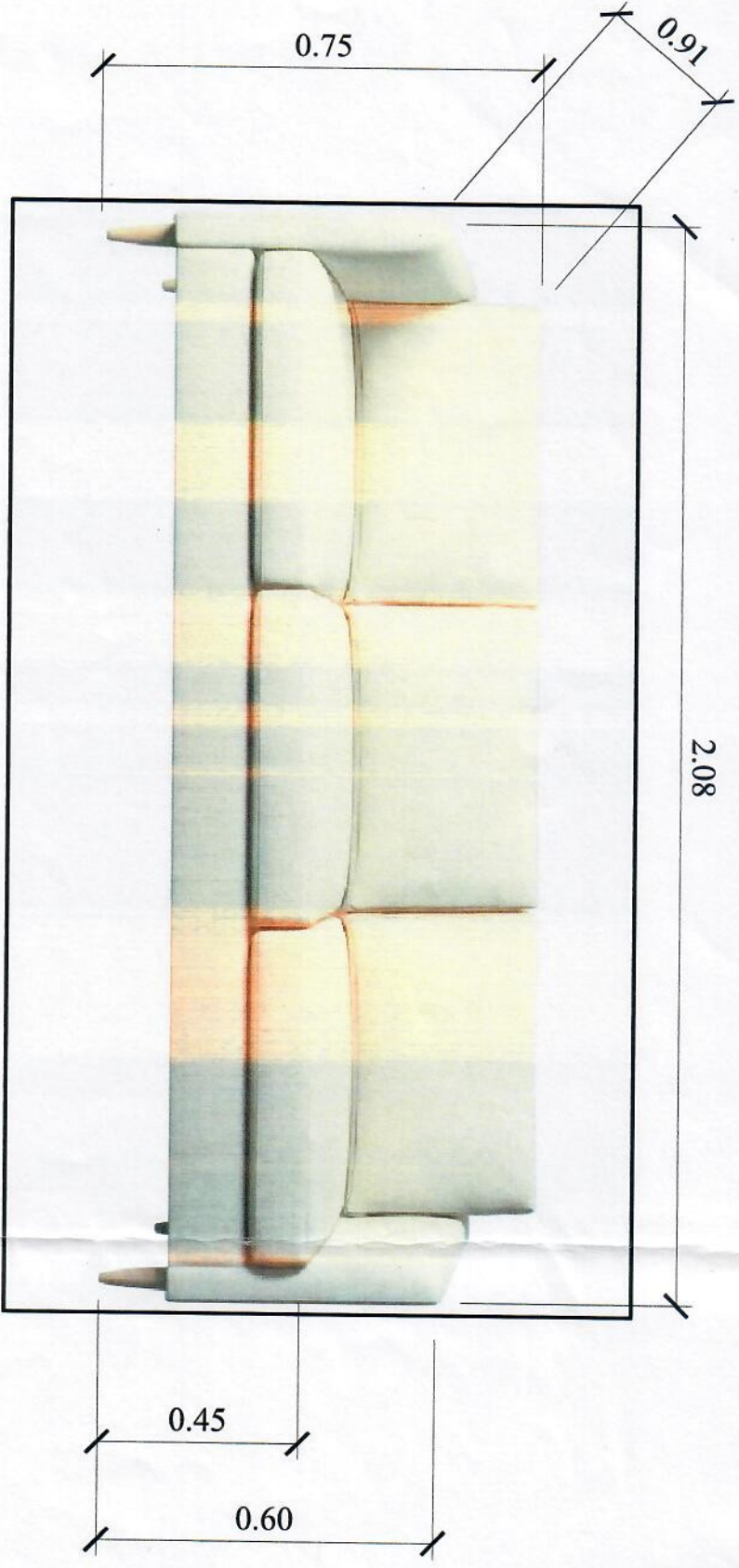

**3-SEATER SOFA  
DESIGN & DIMENSION REFERENCE**



ITEM NO. 2

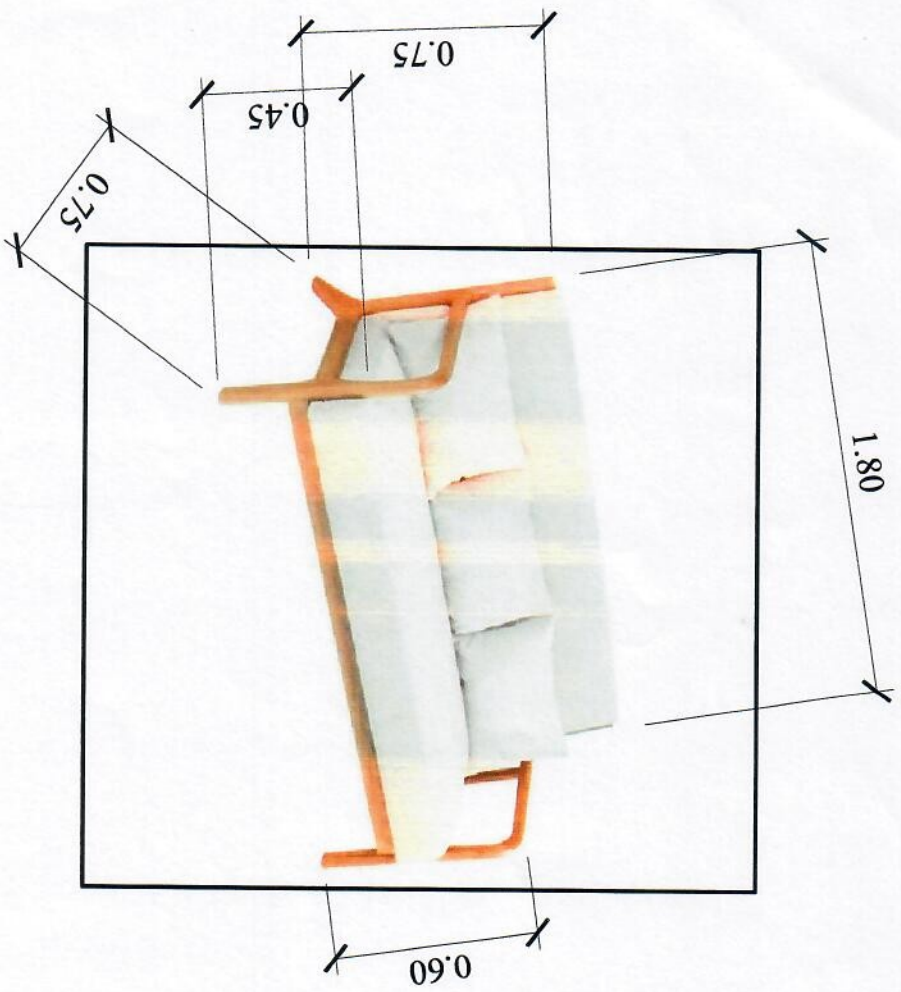

**3-SEATER SOFA**  
**DESIGN REFERENCE & DIMENSION**

ITEM NO. 3

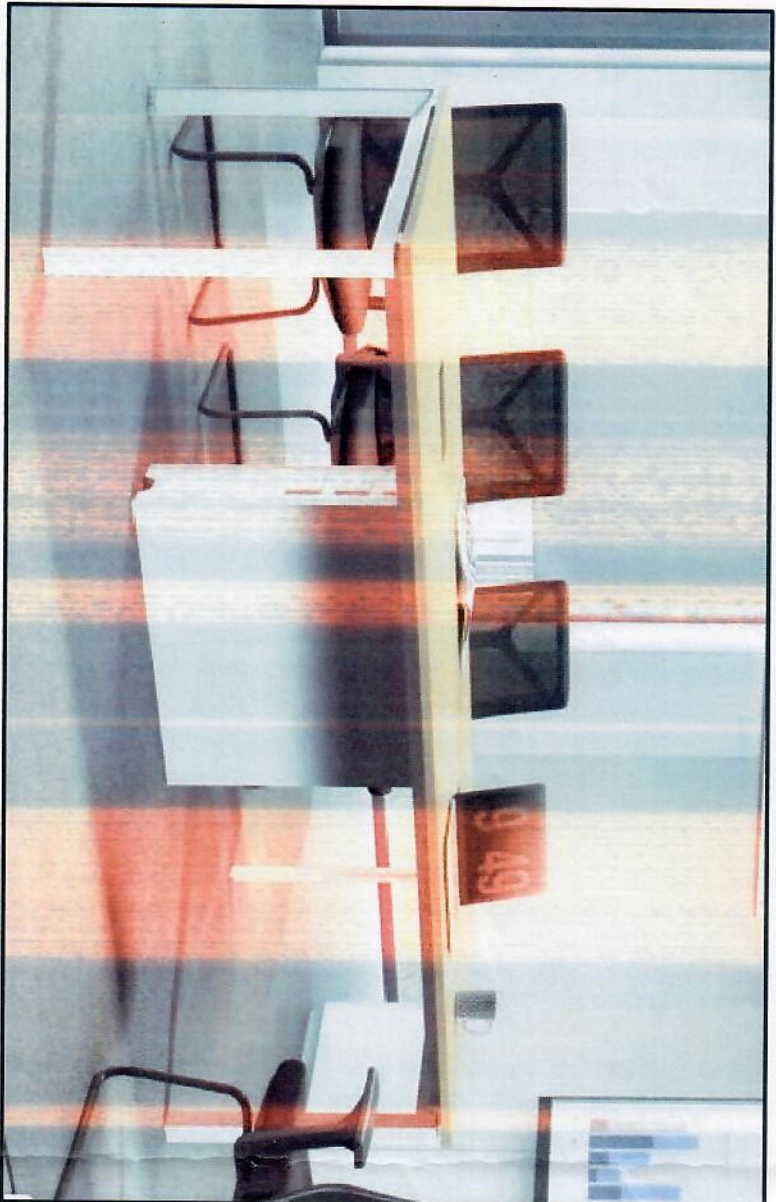

**CONFERENCE TABLE  
DESIGN FOR REFERENCE ONLY  
CHAIRS NOT INCLUDED**



ITEM NO. 4

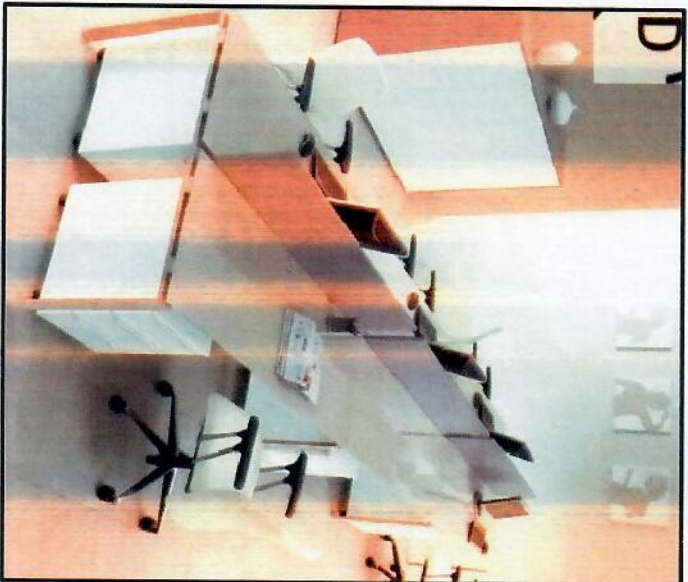

**6-PAX WORK STATION**

**DESIGN FOR REFERENCE ONLY**

**CHAIRS, PARTITION & MOBILE PEDESTALS NOT INCLUDED**

ITEM NO. 5



**1-SEATER SOFA**  
**DESIGN REFERENCE ONLY**



**ITEM NO. 6**

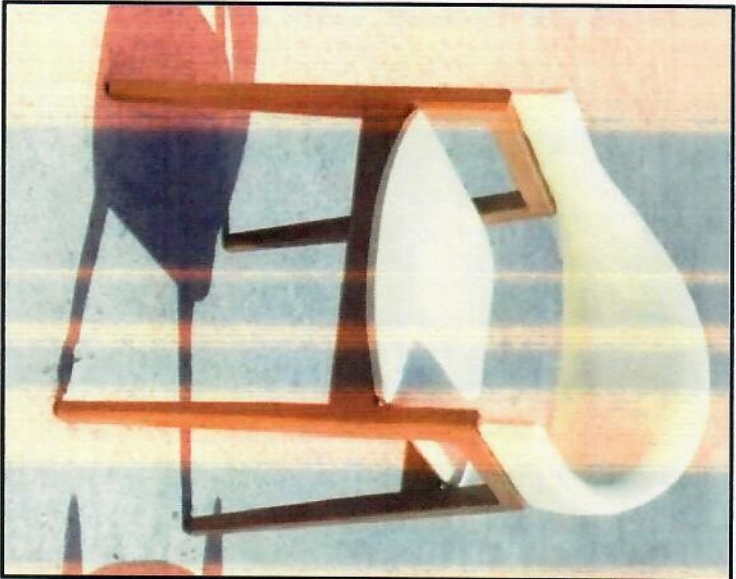

**1-SEATER CHAIR  
DESIGN REFERENCE ONLY**

ITEM NO. 7



OFFICE CHAIR

DESIGN REFERENCE ONLY



ITEM NO. 8

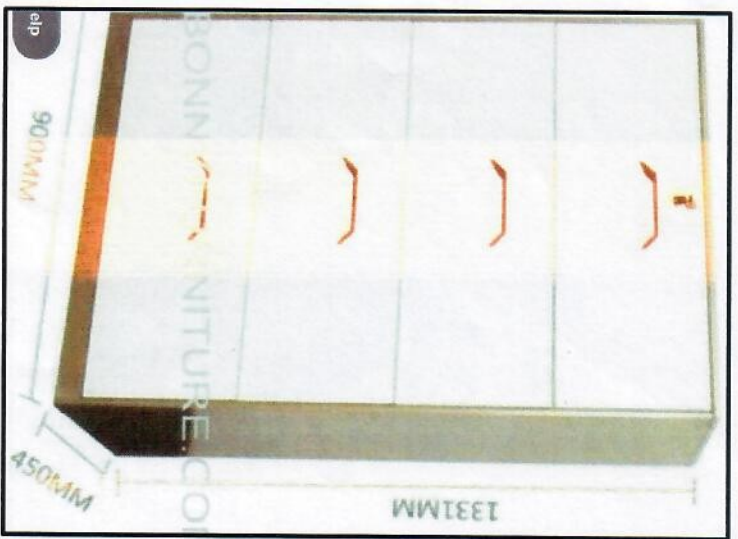

LATERAL FILING CABINET (4-LAYERS)  
DESIGN REFERENCE ONLY

ITEM NO. 9

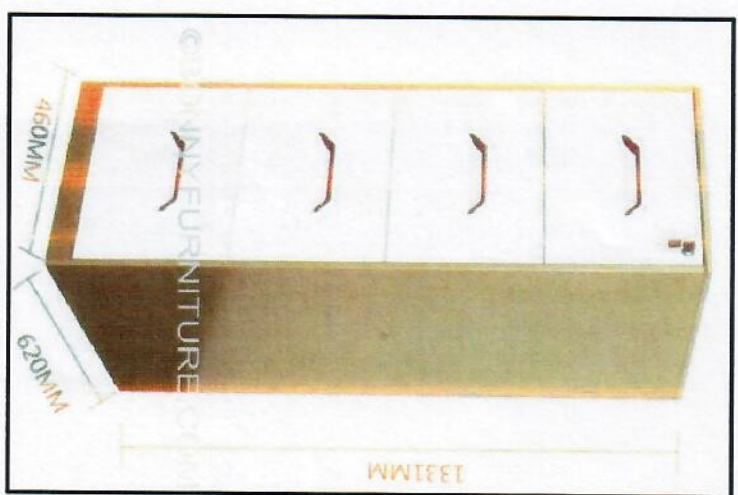

VERTICAL FILING CABINET (4-LAYERS)  
DESIGN REFERENCE ONLY

ITEM NO. 10



MOBILE PEDESTAL  
DESIGN REFERENCE ONLY

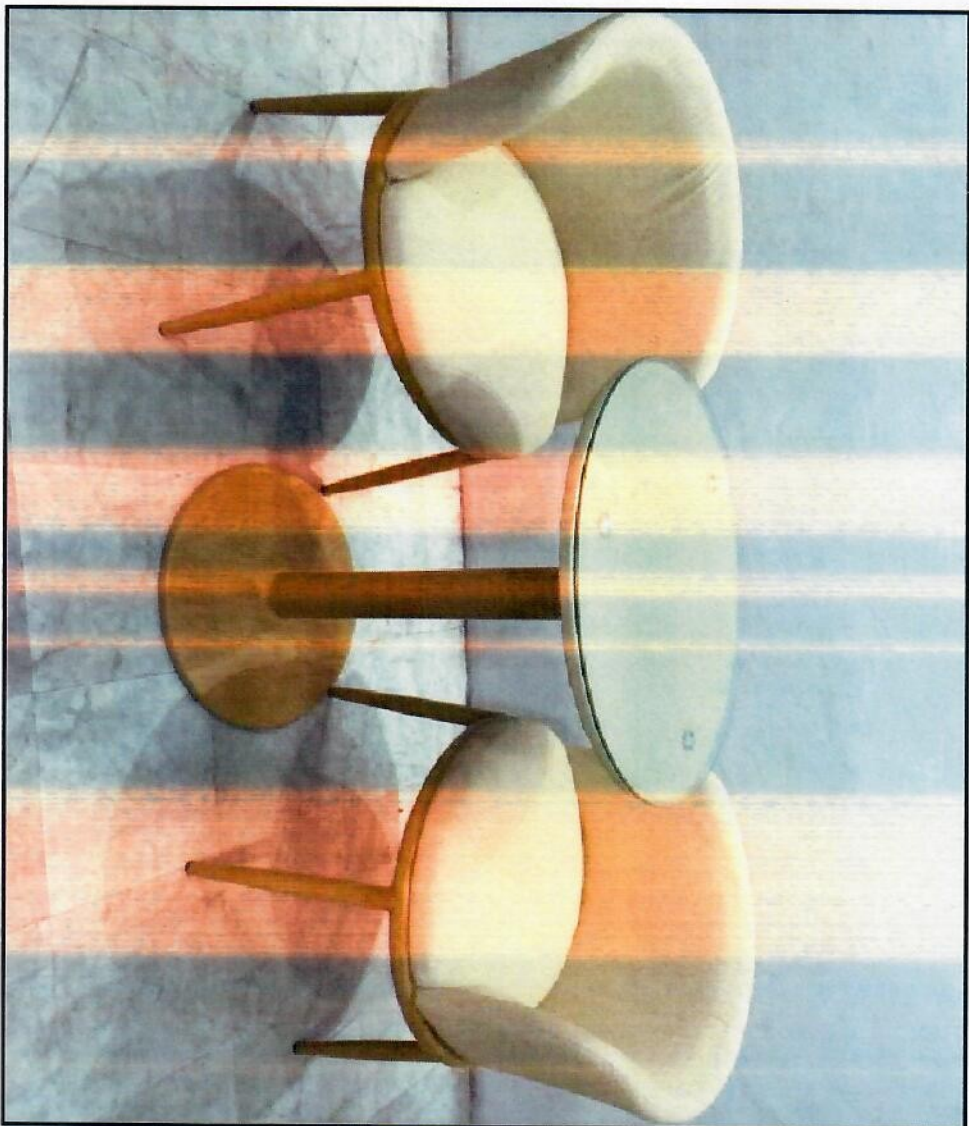

**2-SEATER COFFEE TABLE SET  
DESIGN REFERENCE ONLY**



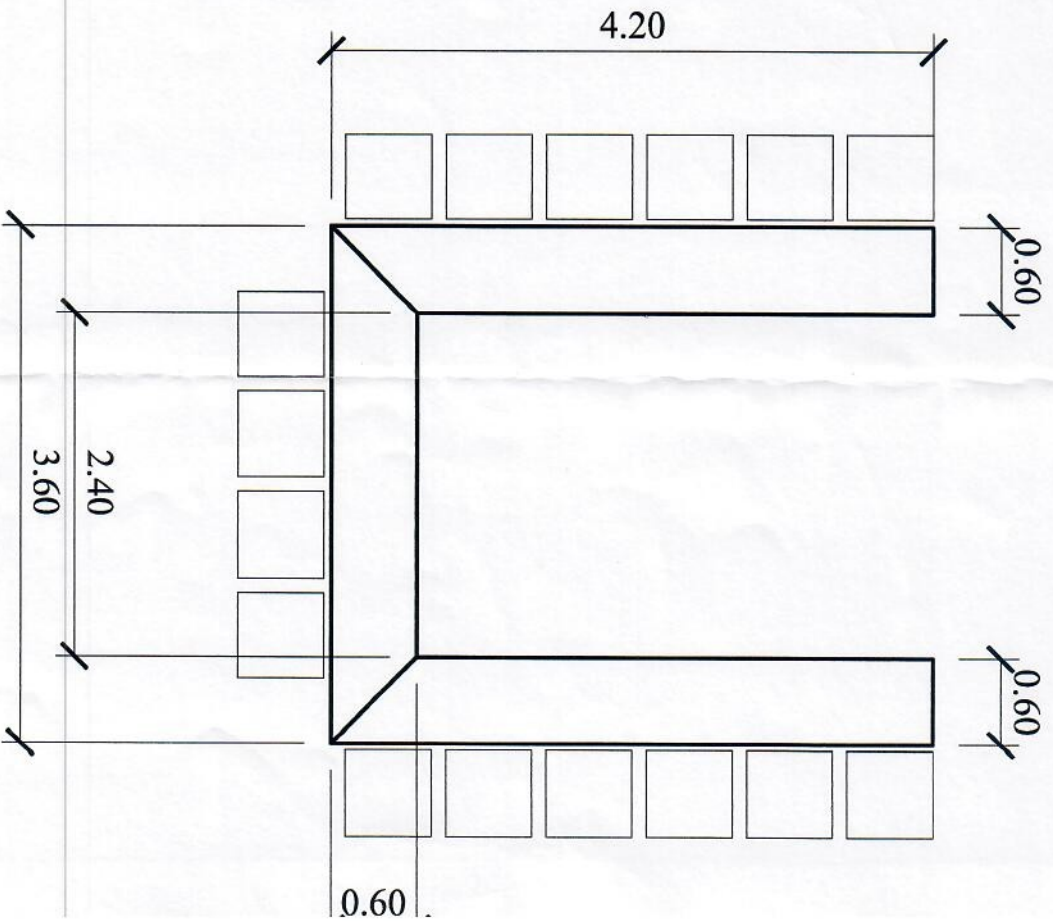
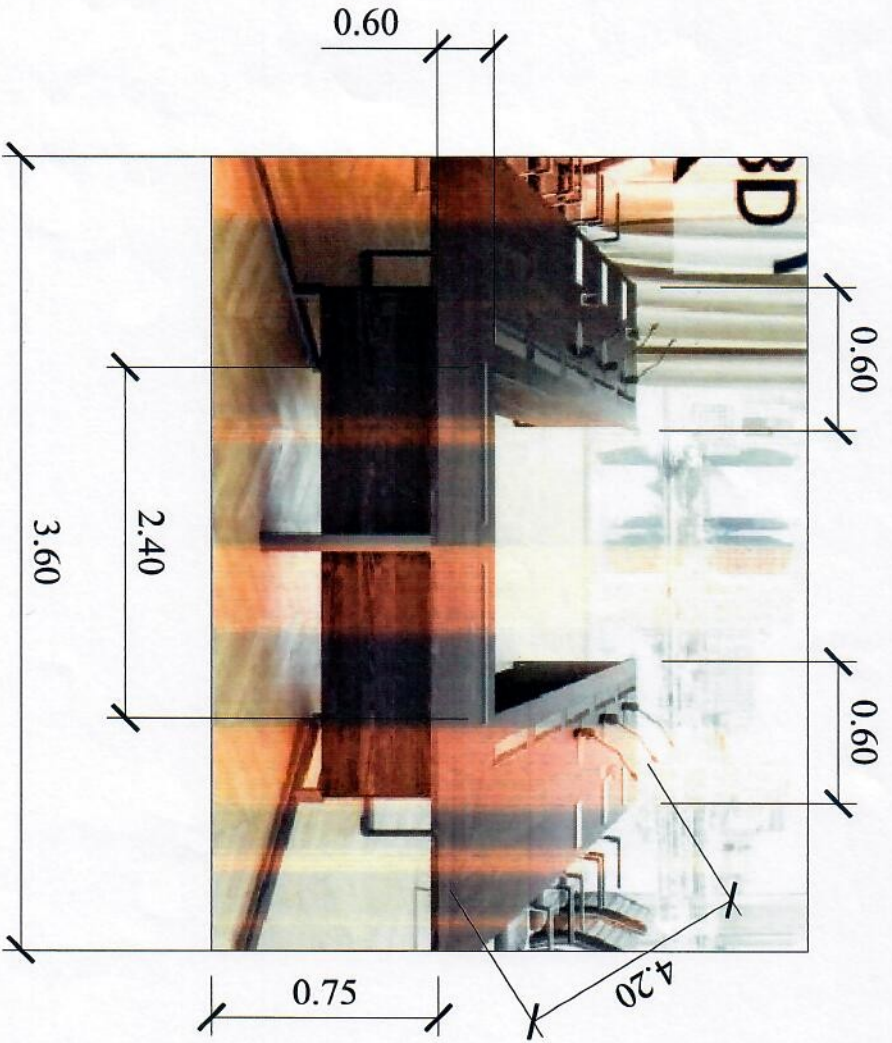

**CONFERENCE TABLE  
DESIGN REFERENCE**

**PLAN**

**MATERIAL:  
CLEAR ACRYLIC**

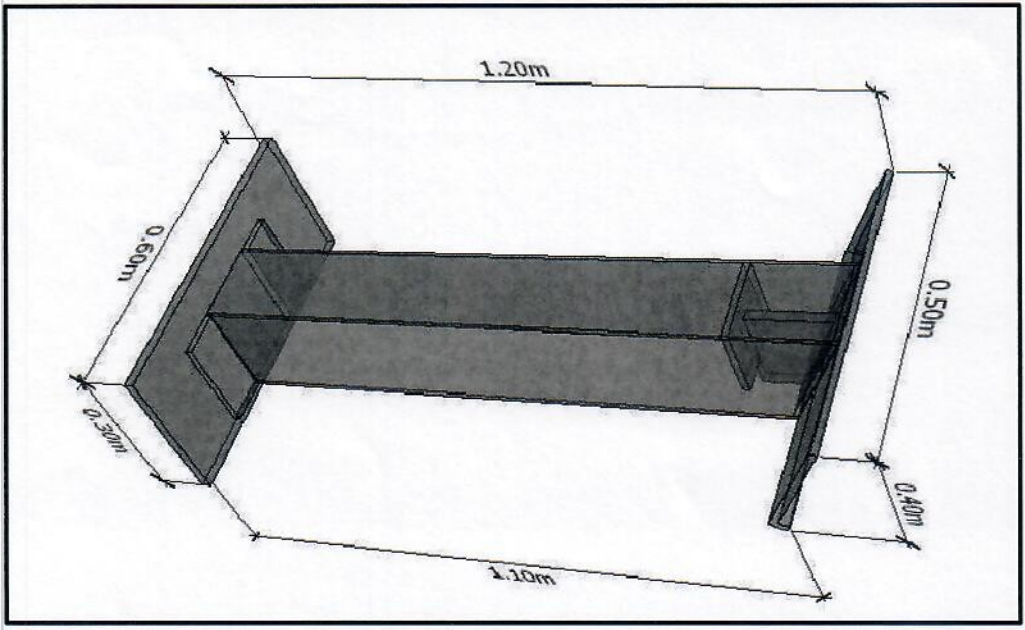

**ACRYLIC PODIUM STAND  
DESIGN REFERENCE & DIMENSION**



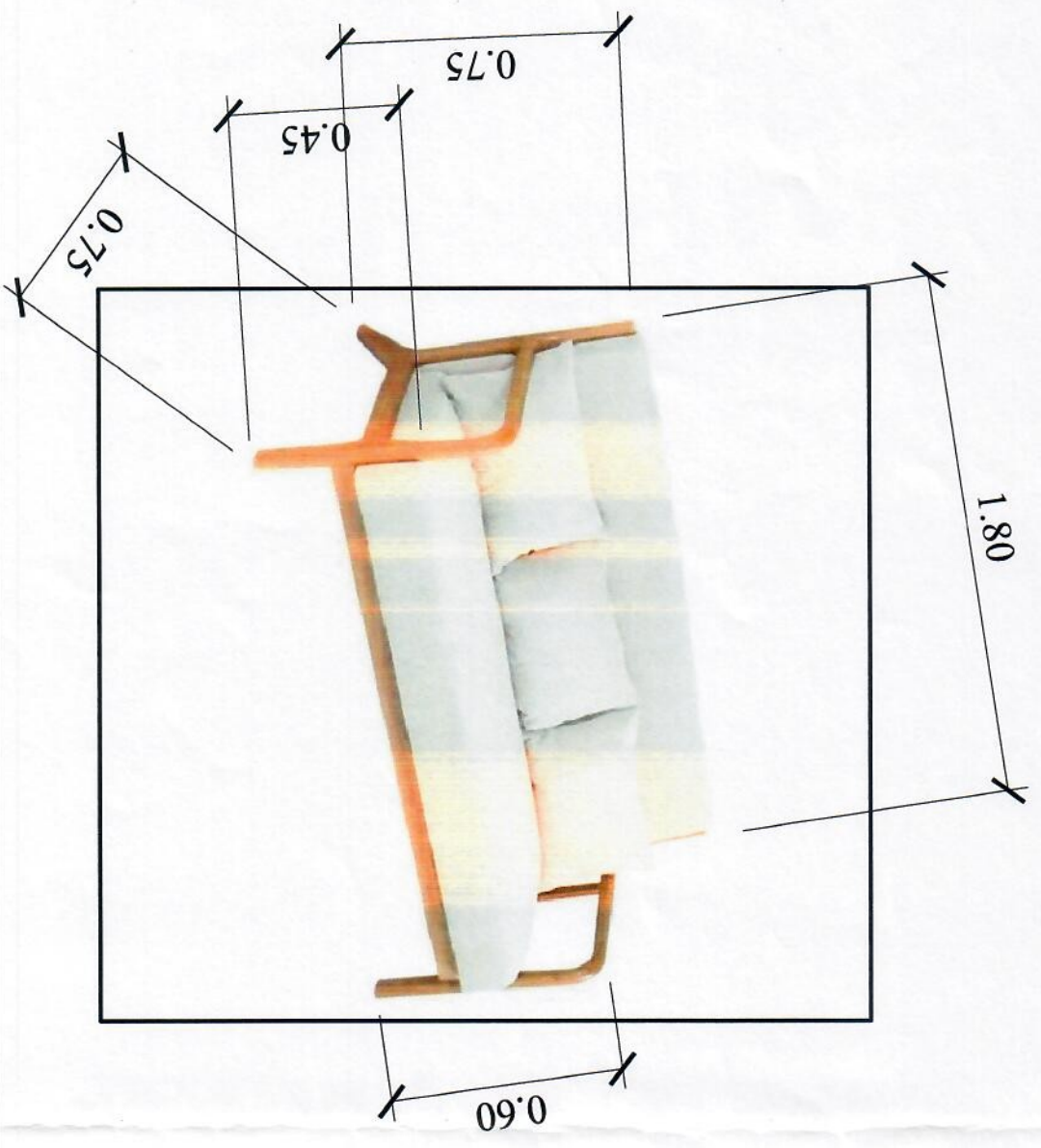

**3-SEATER SOFA**  
**DESIGN REFERENCE & DIMENSION**

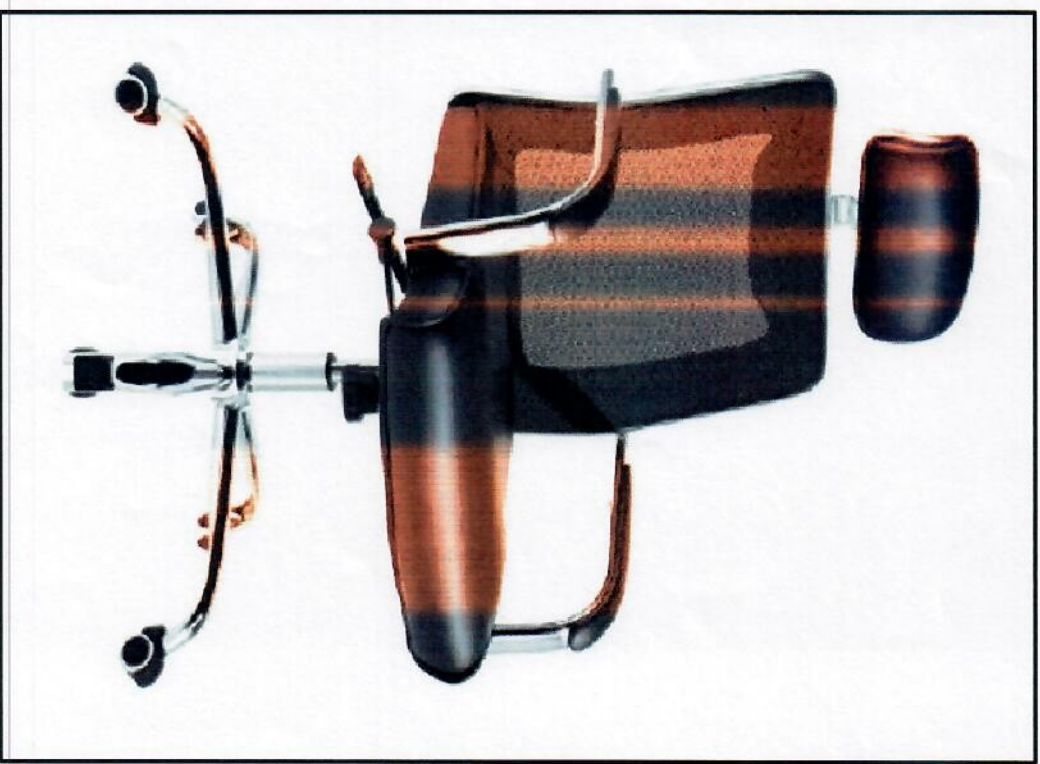

**EXECUTIVE CHAIR  
DESIGN REFERENCE ONLY**



**1-SEATER SOFA  
DESIGN REFERENCE ONLY**

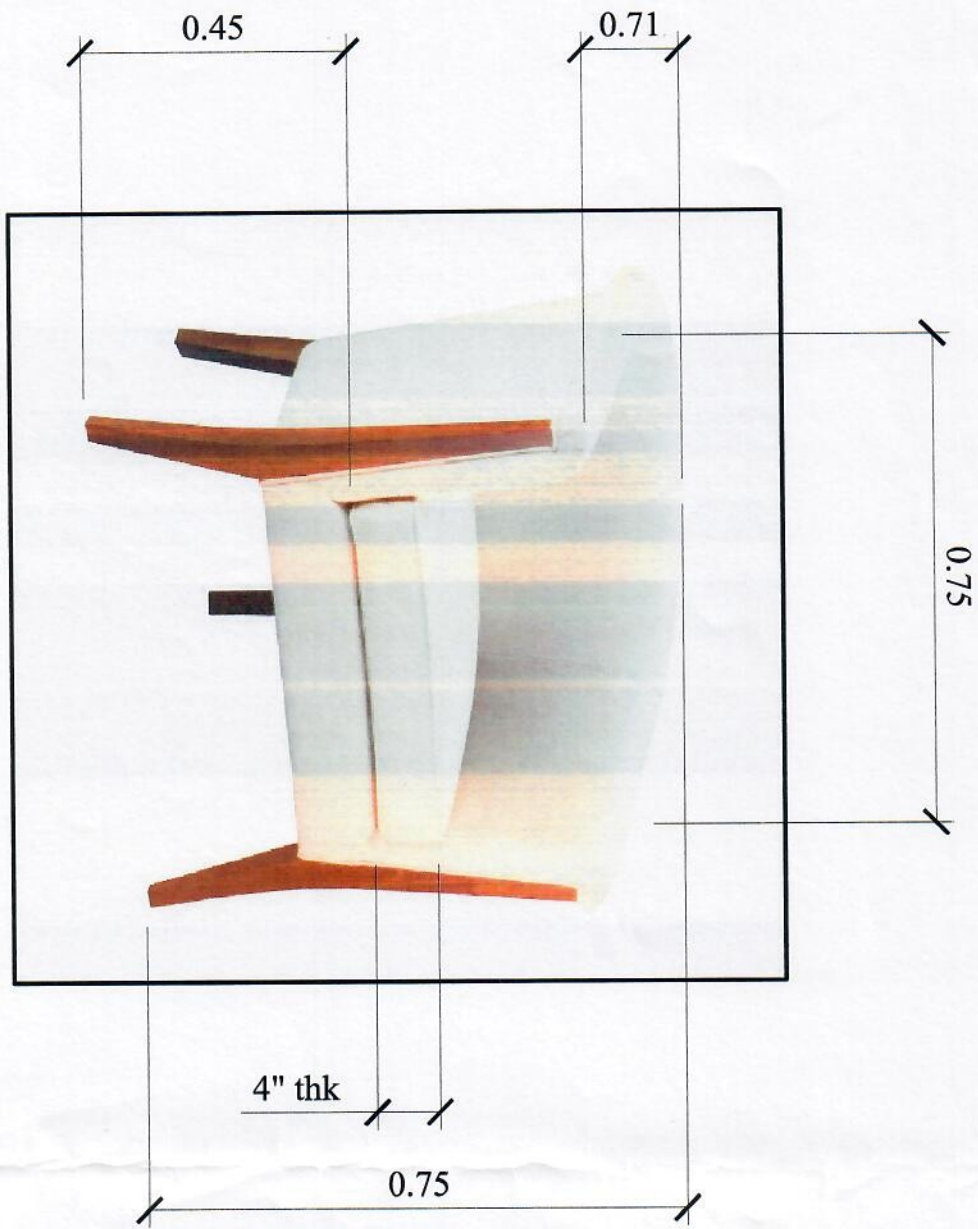

ITEM NO. 16